

**SELECTED  
ARCHITECTURAL  
DETAILS**

**The Pencil Points Series—1940**

# BED ALCOVE

SELECTED DETAILS

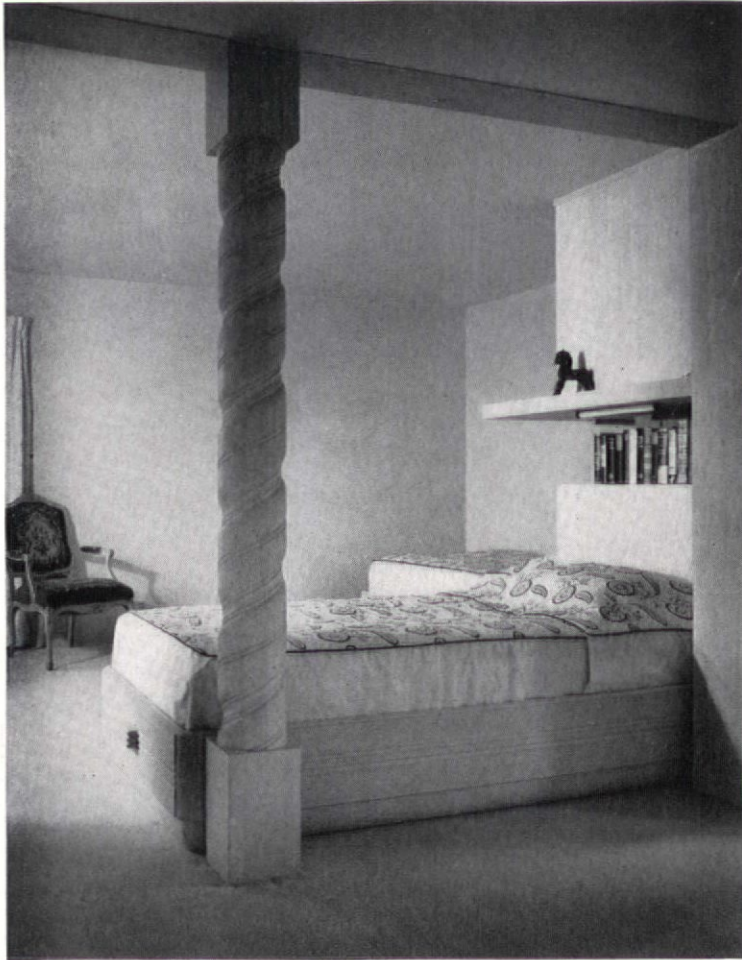

RICHARD GARRISON

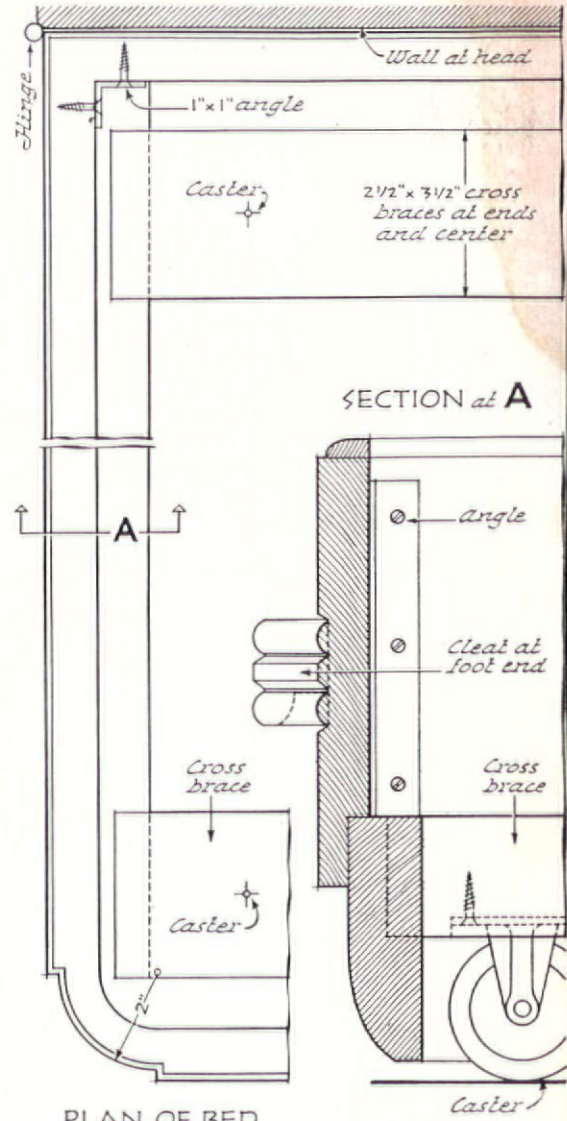

PLAN OF BED  
3" scale

ELEVATION 3/8" scale

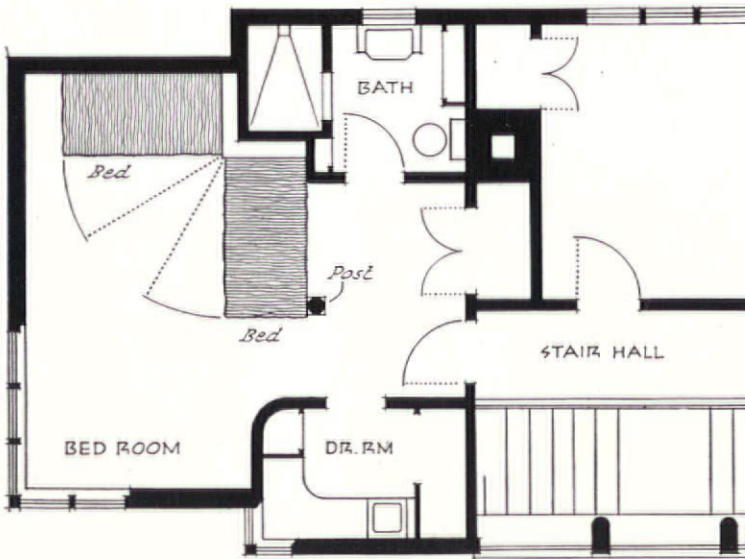

PLAN OF SUITE 1/8" scale

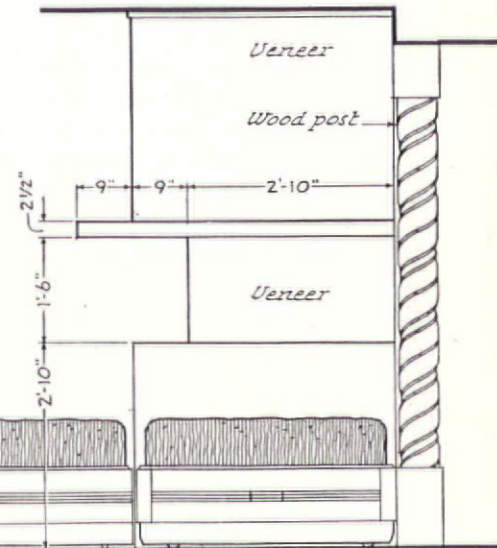

J. LISTER HOLMES  
*Architect*

# BED ALCOVE

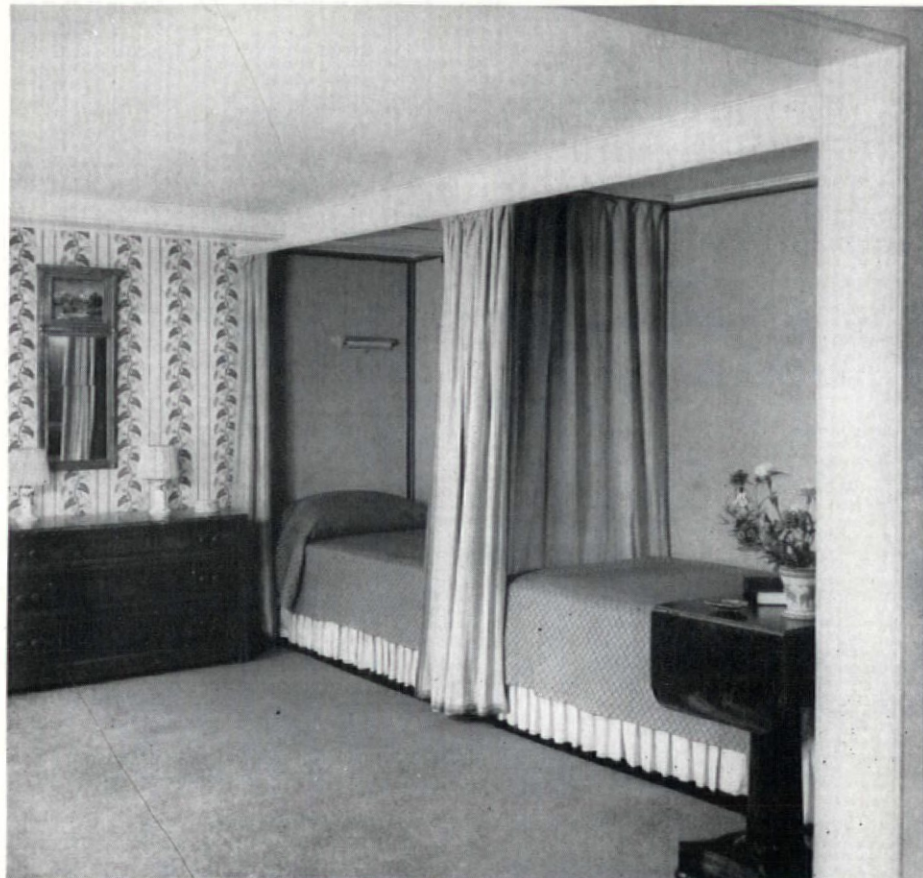
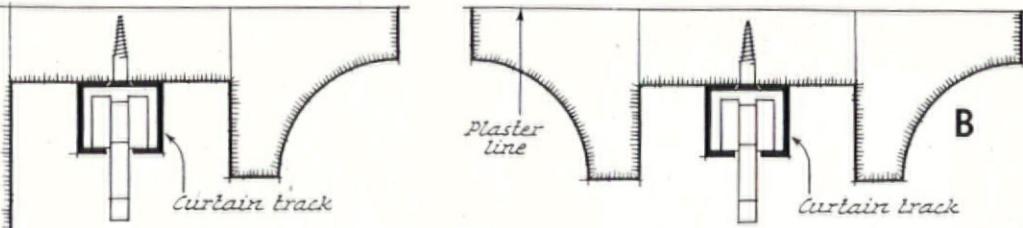

GEORGE H VAN ANDA

SECTION  
at A  
full size

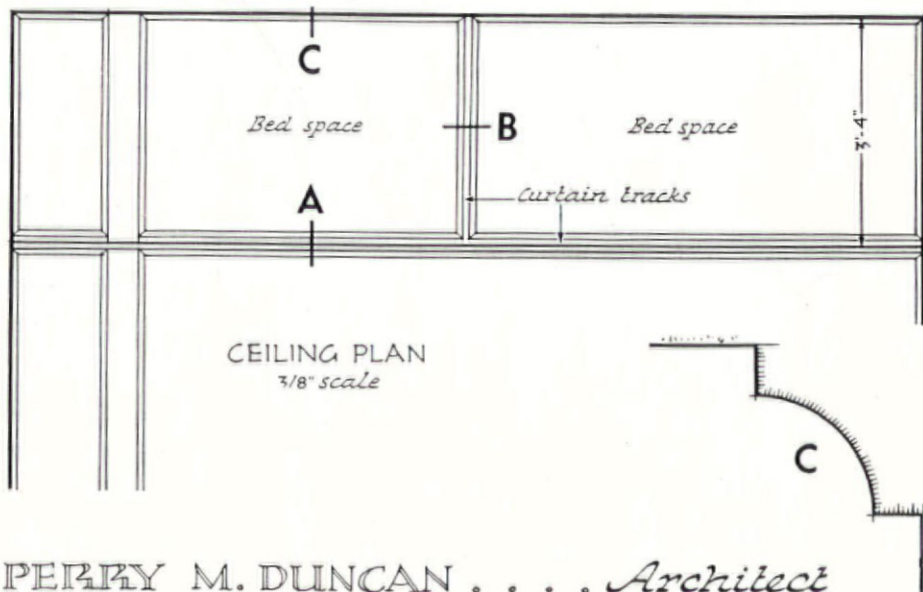

PERRY M. DUNCAN . . . . Architect

SELECTED DETAILS

**SELECTED  
ARCHITECTURAL  
DETAILS**

**The Pencil Points Series—1940**



**1941**

**THE REINHOLD PUBLISHING CORPORATION**

**330 West 42nd Street**

**New York, N. Y.**

*Copyright, 1941, by*  
THE REINHOLD PUBLISHING CORPORATION  
New York, N. Y.

# I N D E X



	PAGE
1. ENTRANCES .....	5
2. STAIRWAYS AND STAIR RAILS .....	10
3. FIREPLACES .....	19
4. CUPBOARD .....	26
5. CHILDREN'S ROOMS .....	27
6. RESIDENCE BARS .....	33
7. BUILT-IN RADIO .....	36
8. GAME ROOM .....	37
9. BOW WINDOWS .....	39
10. USES OF GLASS .....	41
11. LIGHTING FIXTURES .....	49
12. EXTERIOR DETAILS .....	50
13. GARDEN ROOM .....	51
14. CHILD'S PLAYHOUSE .....	52
15. FILLING STATIONS .....	53
16. BUS STATION .....	57
17. BOATHOUSES .....	59
18. DINING BOOTHS .....	61
19. CHURCH FURNITURE AND FITMENTS .....	63
20. CHURCH DOORS .....	67

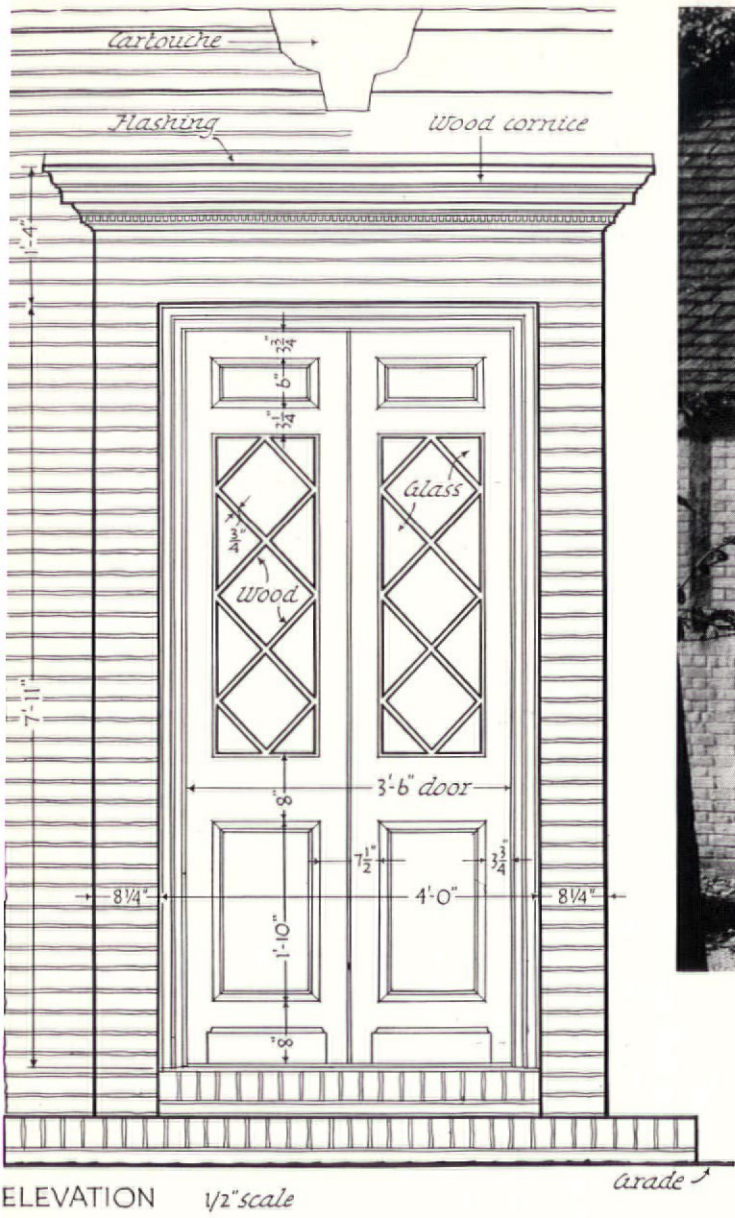

ELEVATION 1/2" scale



THE HUGHES CO.

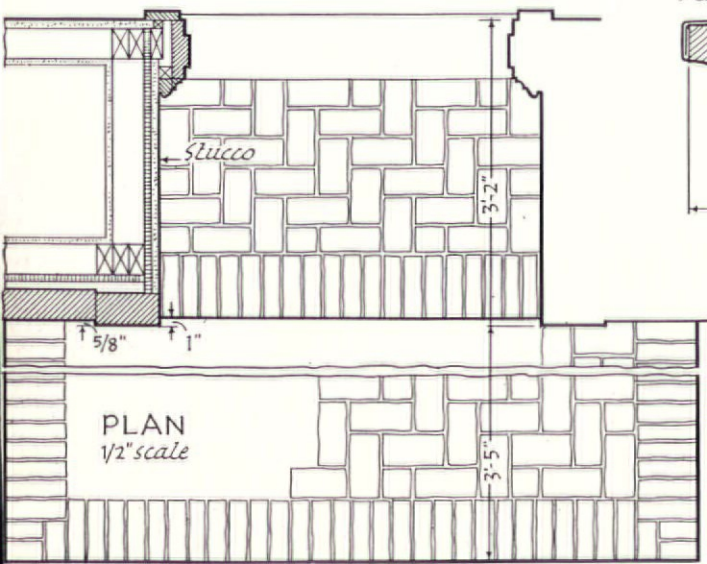

PLAN 1/2" scale

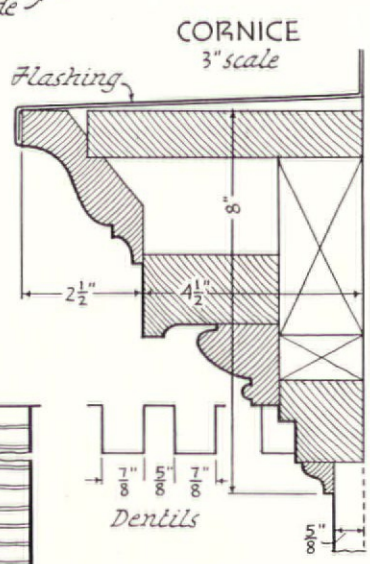

CORNICE 3" scale

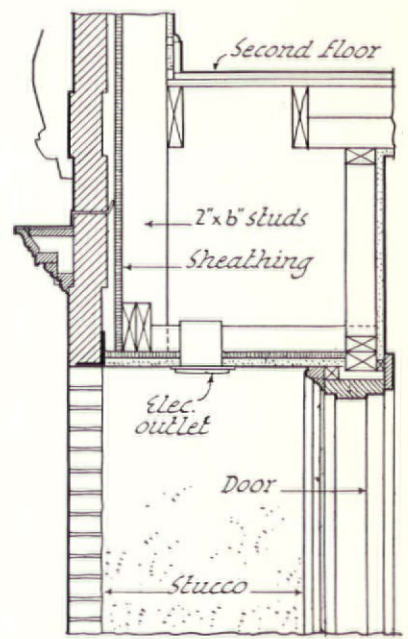

SECTION thru HEAD 1/2" scale

PRENTICE SANGER... Architect

WALDRON FAULKNER... *Architect*



J. F. STOWELL

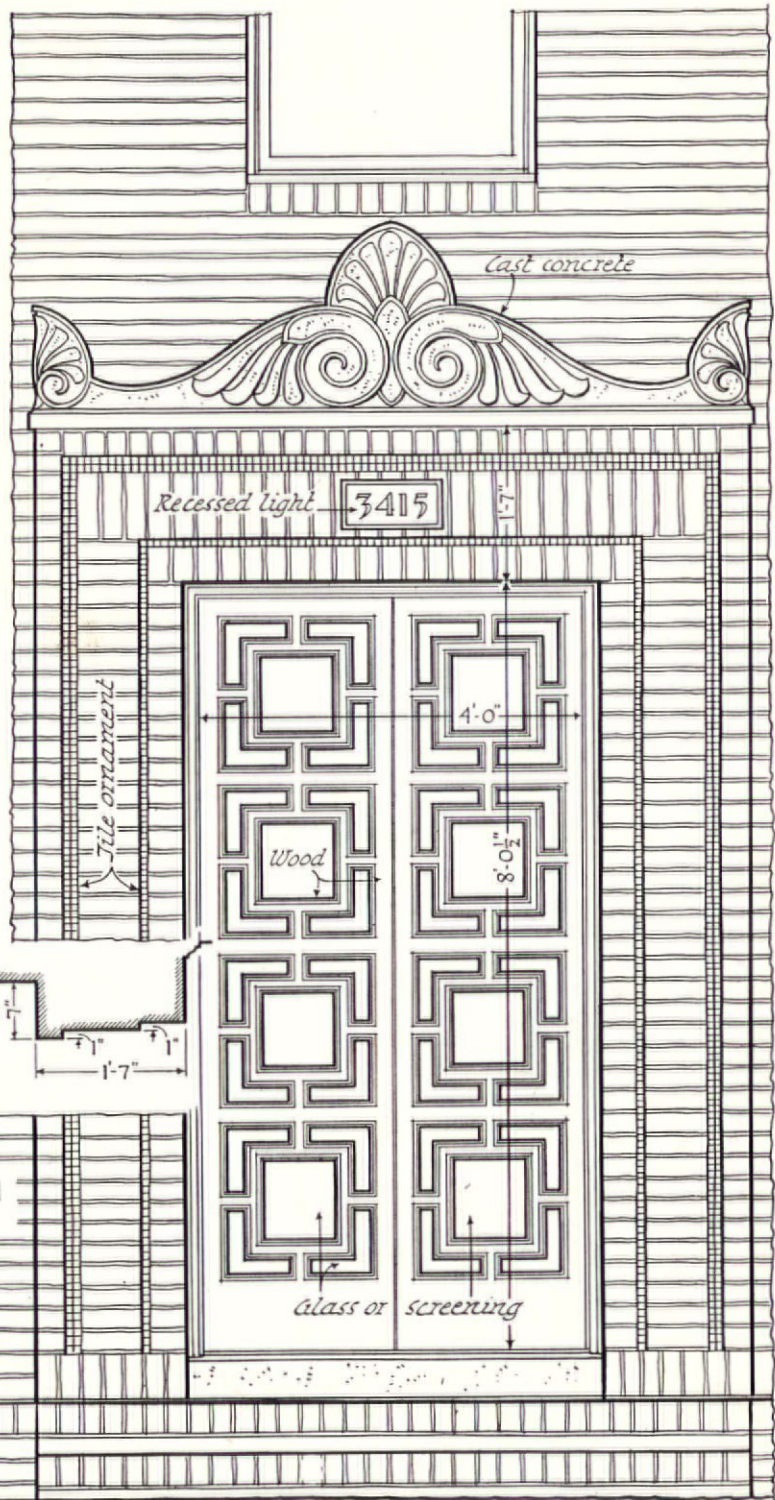



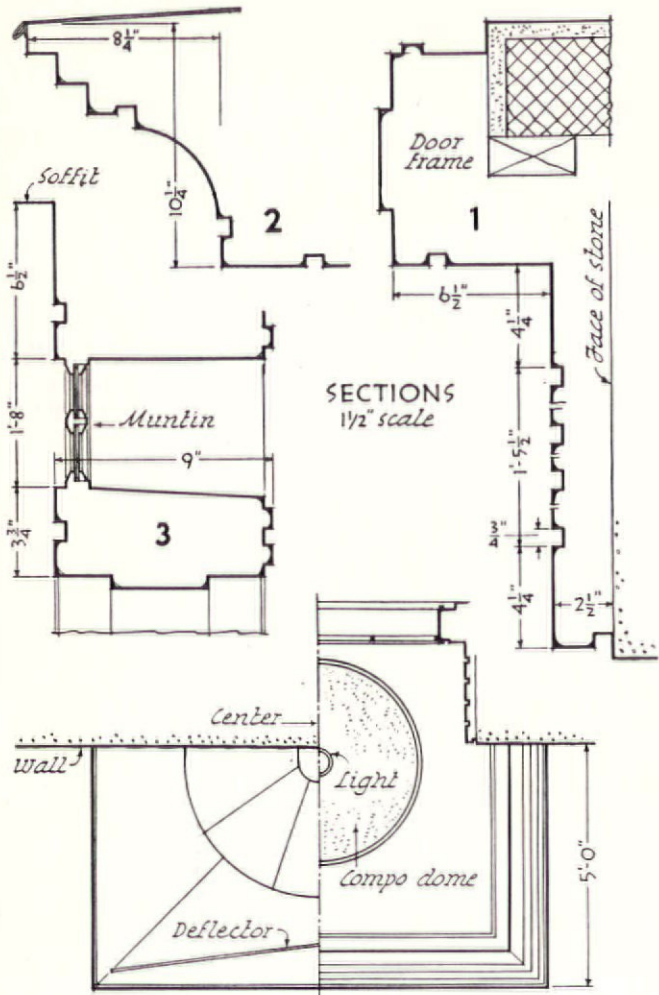

PLAN 1/4" scale

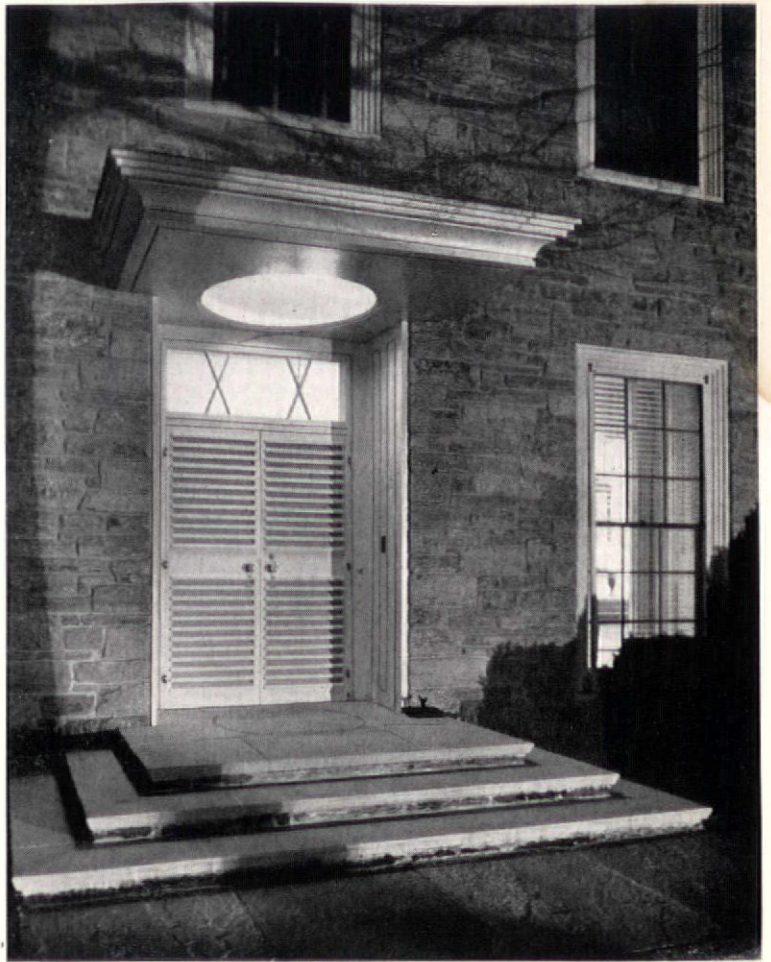

F. S. LINCOLN

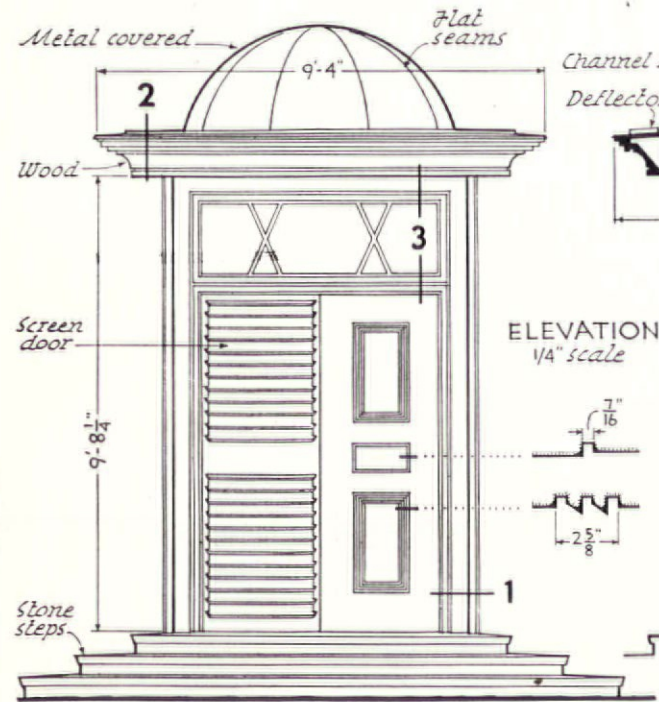

ELEVATION 1/4" scale

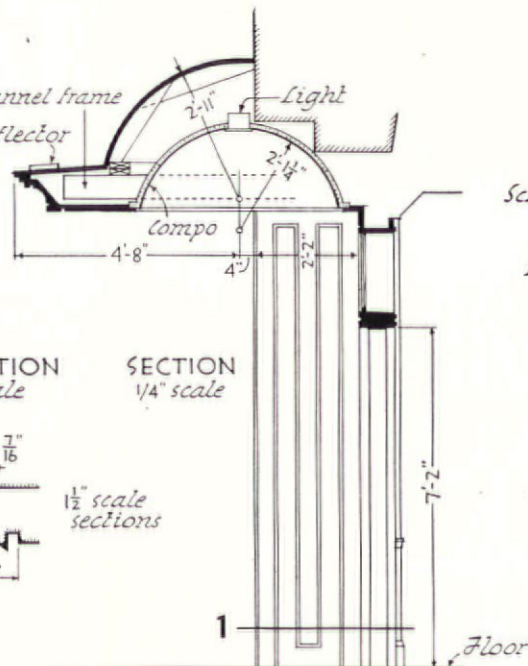

SECTION 1/4" scale

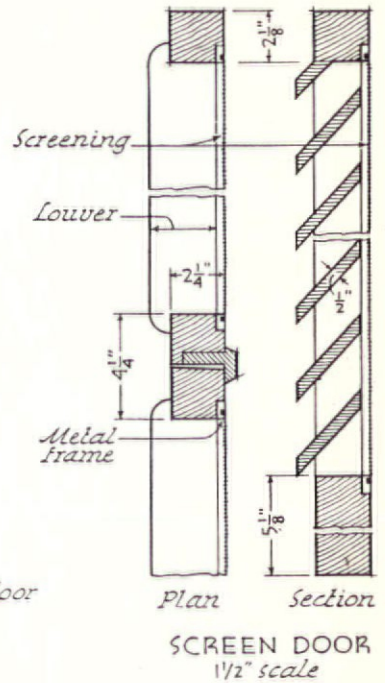

SCREEN DOOR 1 1/2" scale

ERNEST A. GRUNSFELD, Jr. . . . *Architect*

WALLACE F. YERKES, . . . ASSOCIATE

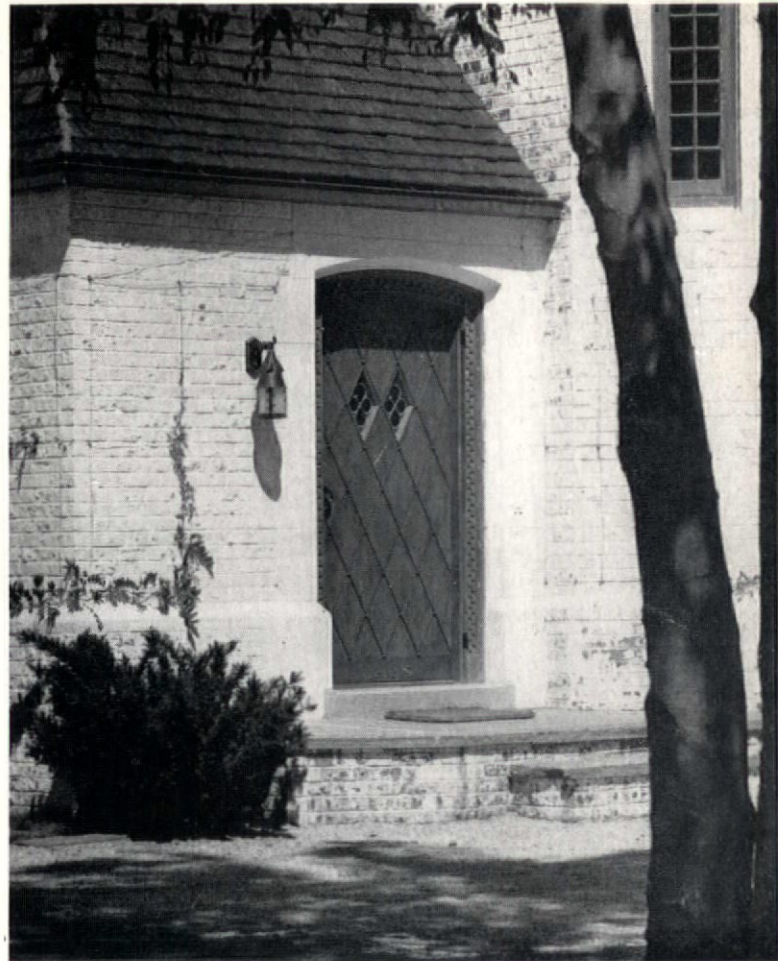
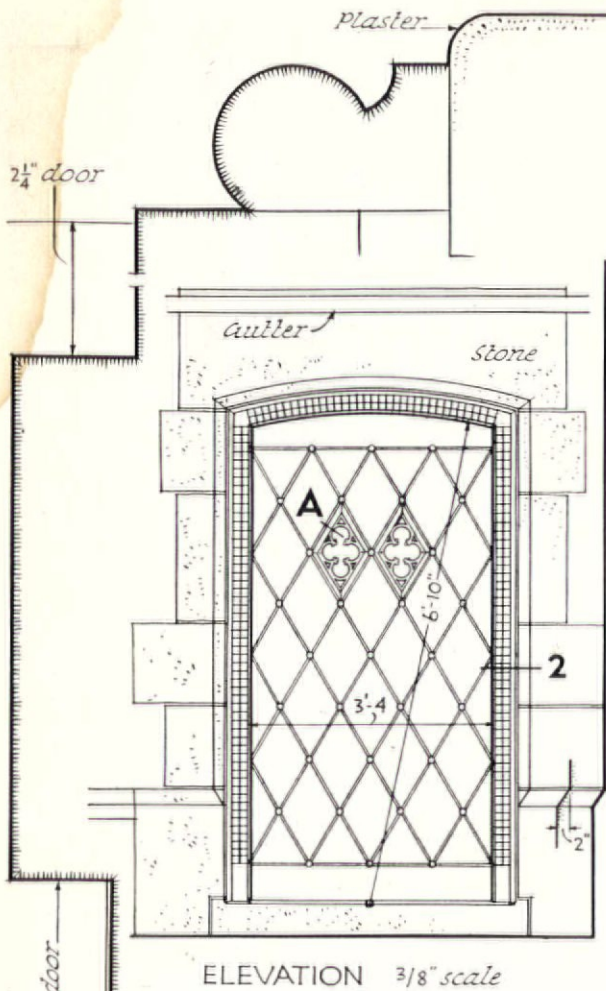

RODNEY McCAY MORGAN

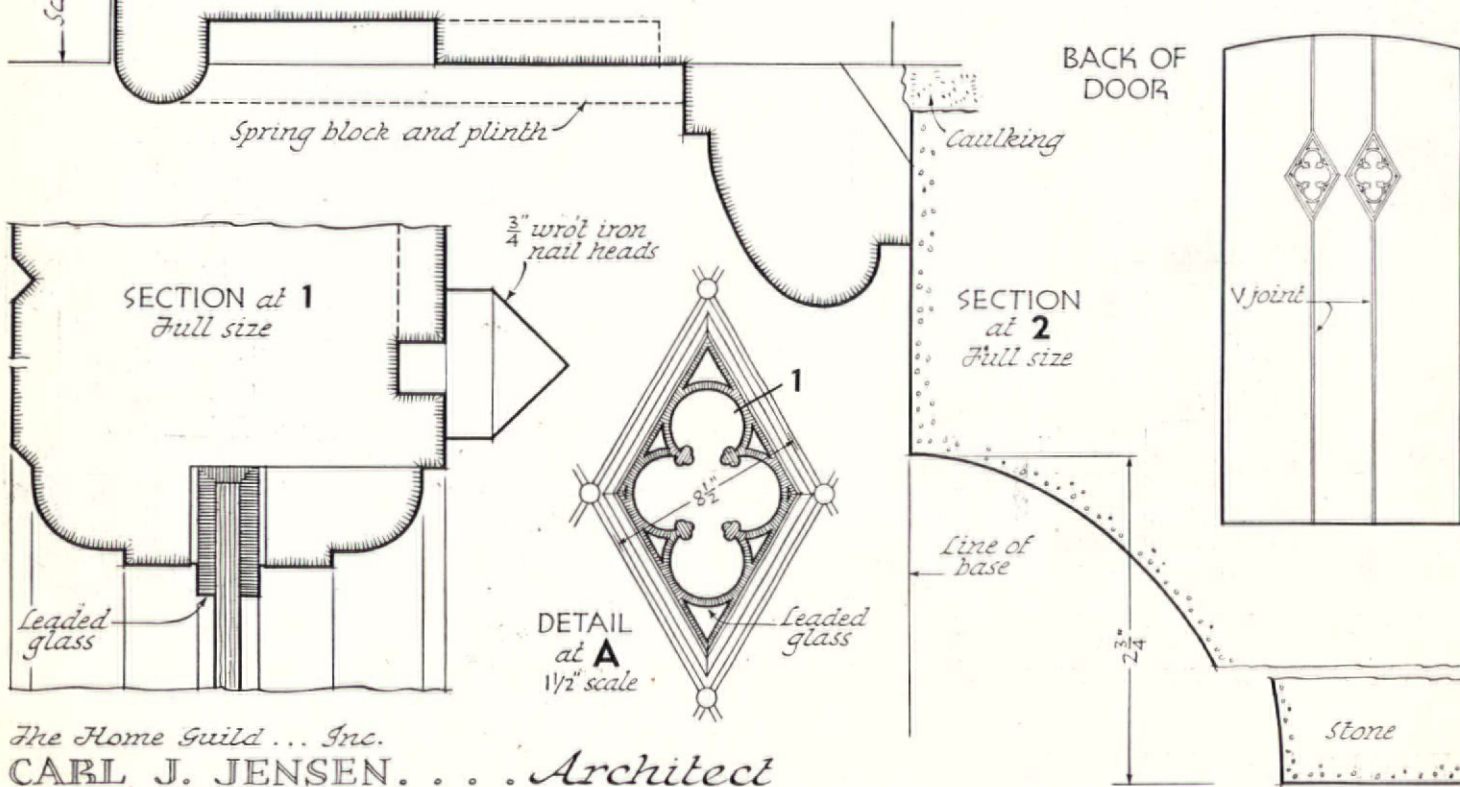

The Home Guild ... Inc.  
 CARL J. JENSEN. . . . Architect

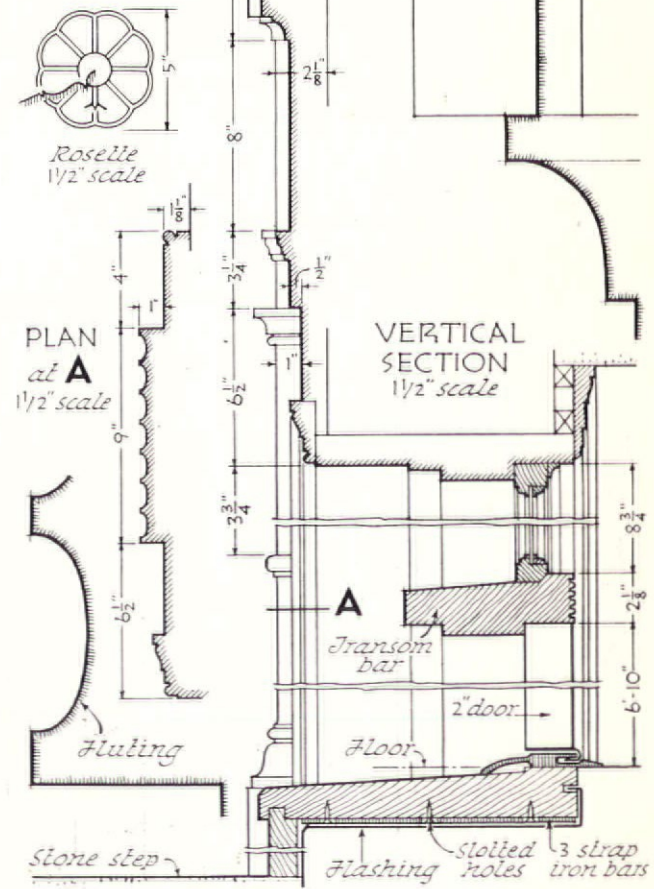
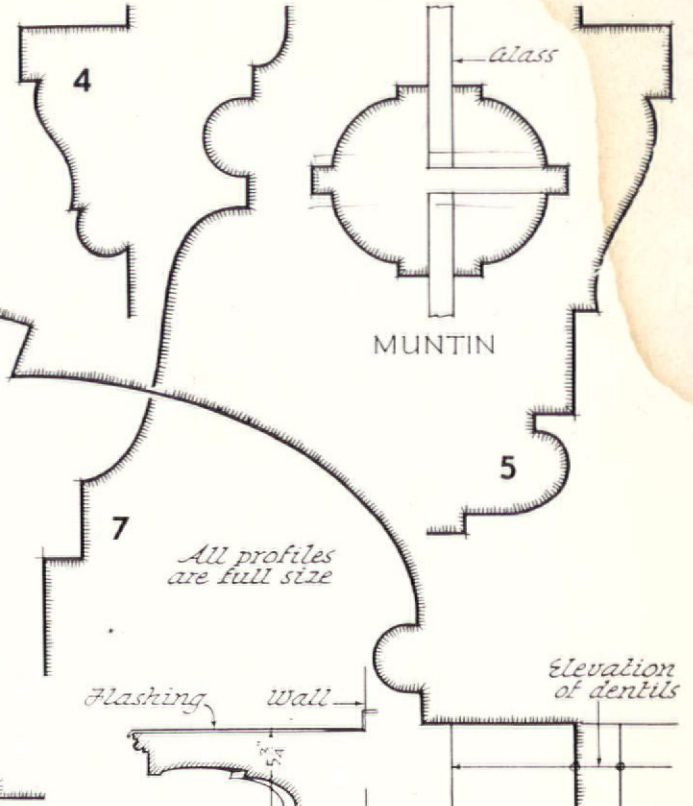
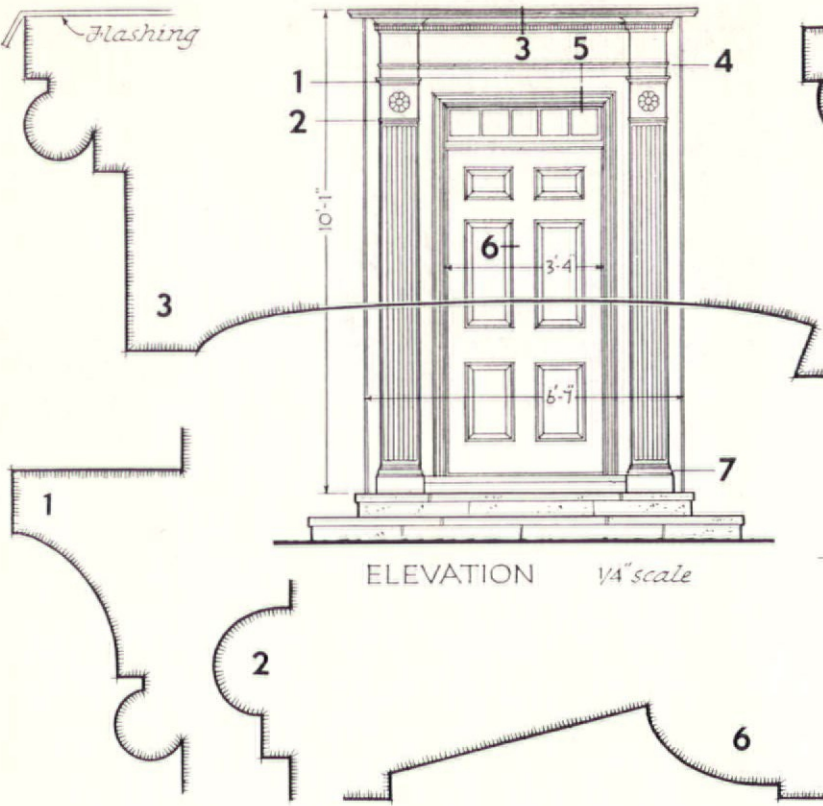

ELDRIDGE SNYDER  
*Architect*

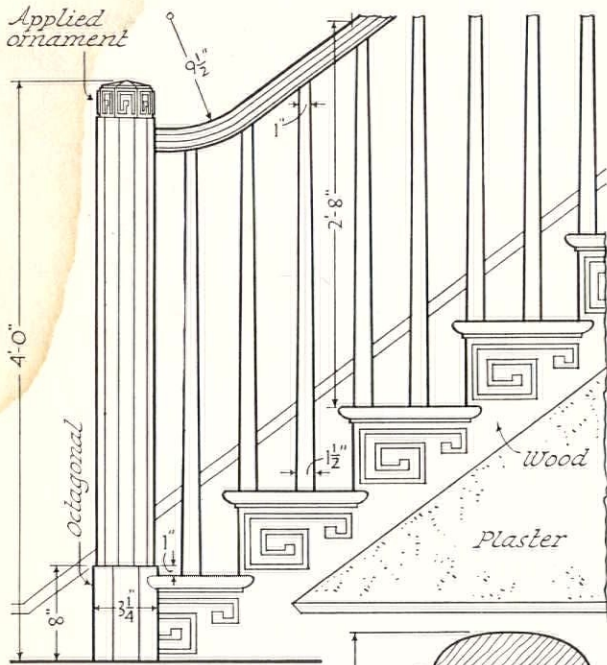

ELEVATION  $3/4$ " scale

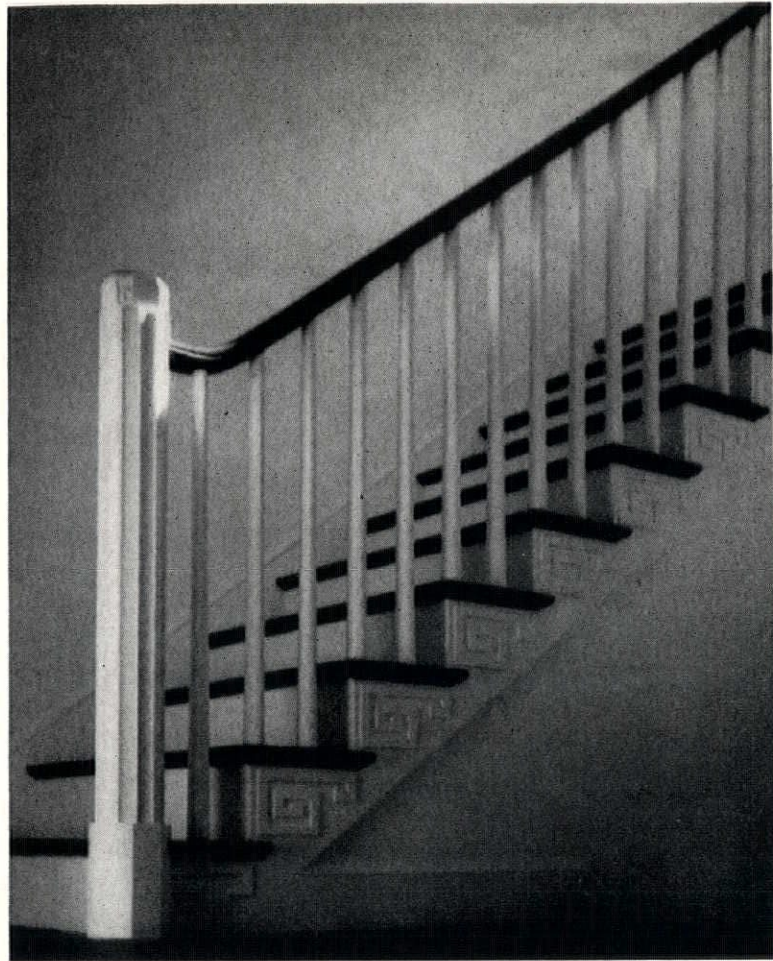

STEPHEN EDSON

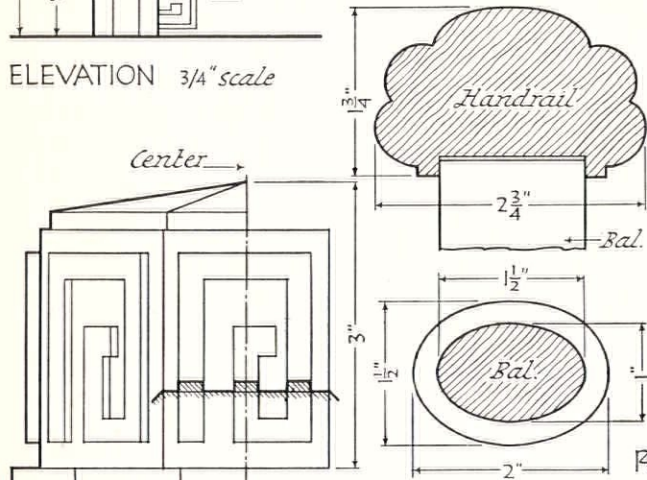

RAIL SECTION *Half full size*

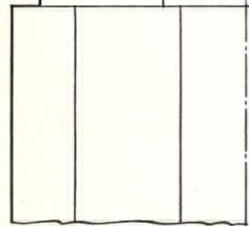

NEWEL POST  
*Half full size*

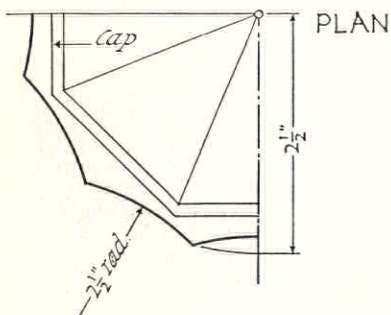

PLAN

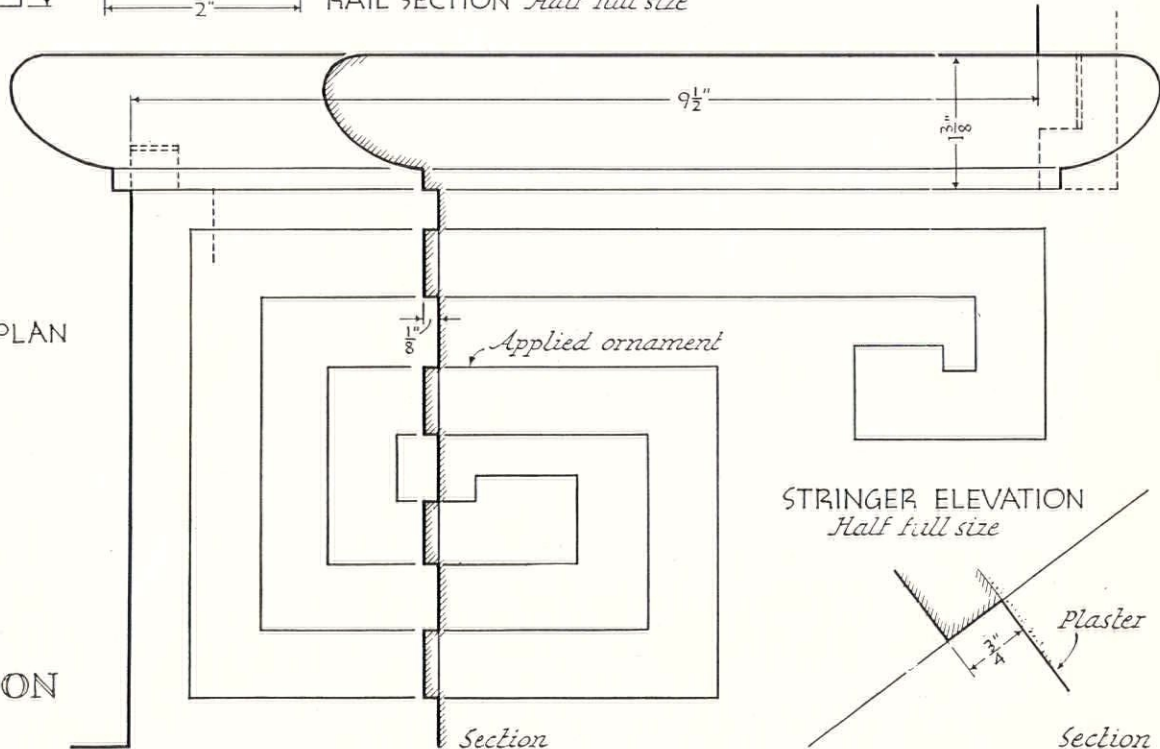

STRINGER ELEVATION  
*Half full size*

Section

Section

O'HARA & EDSON  
*Architects*



RODNEY M'CAV MORGAN

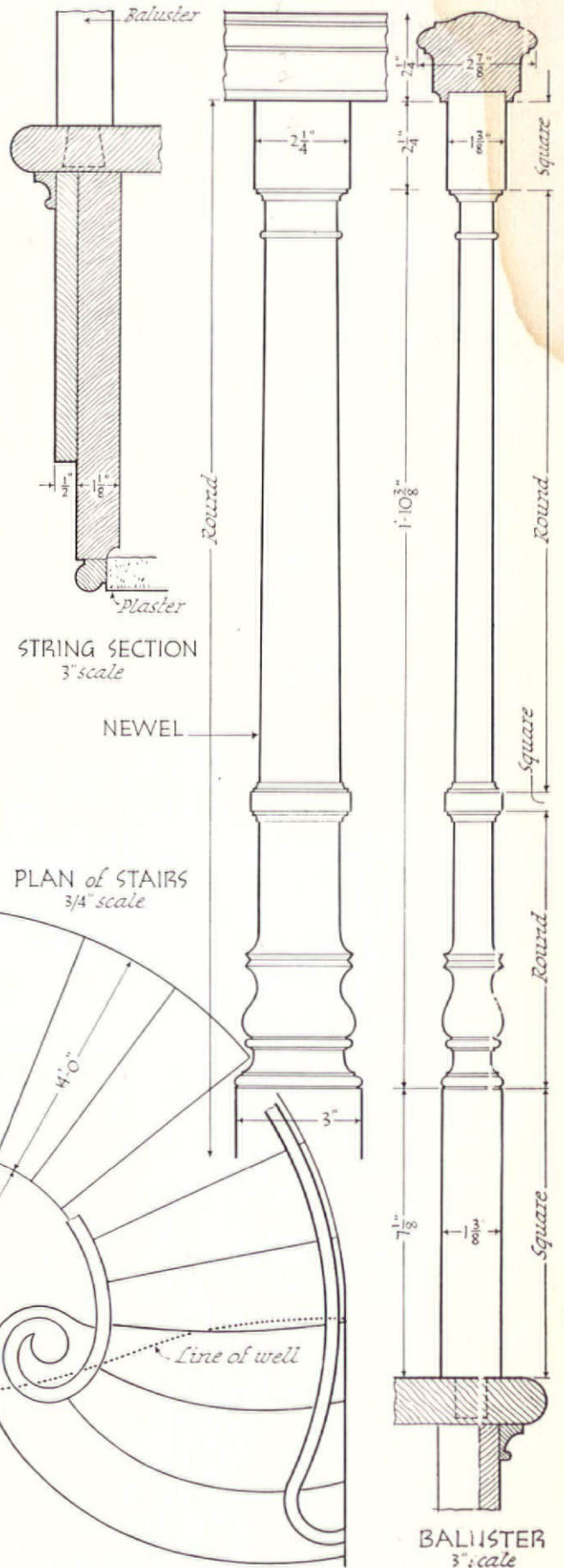

PLAN of STAIRS  
3/4" scale

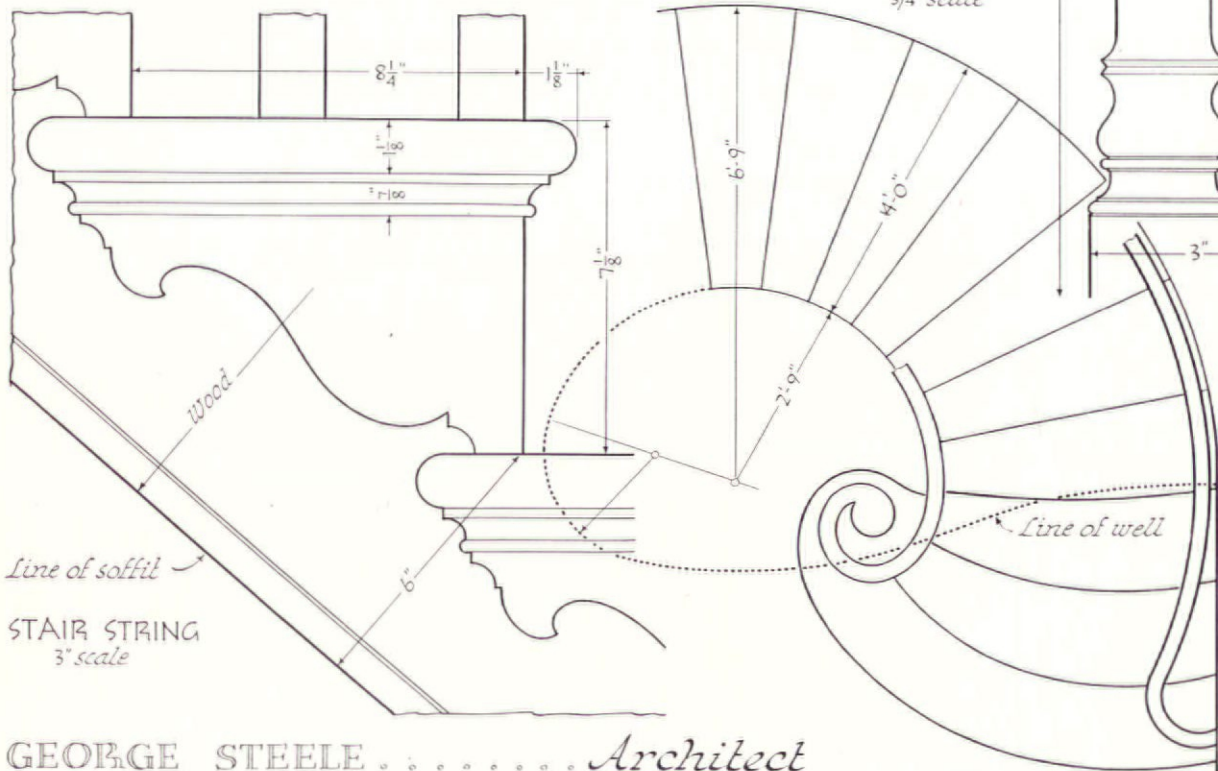

GEORGE STEELE . . . . . Architect



F. S. LINCOLN

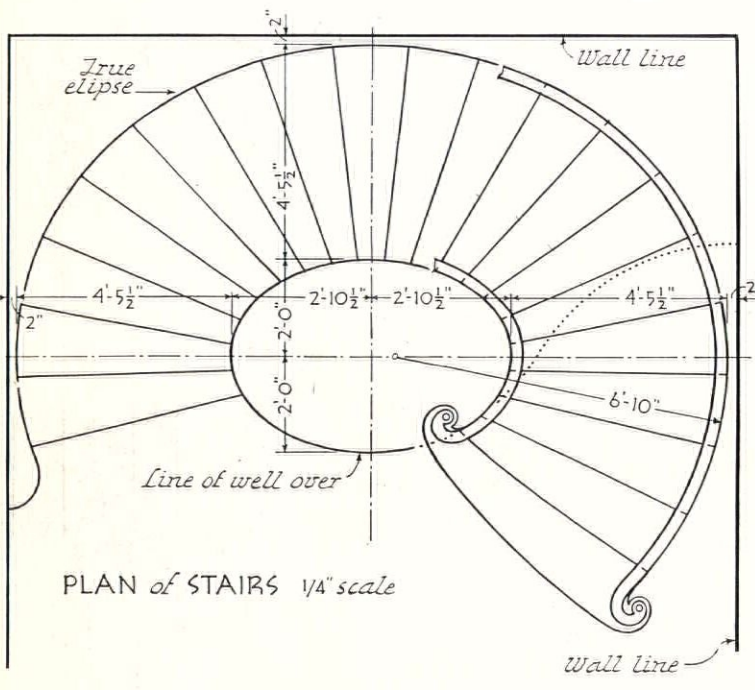
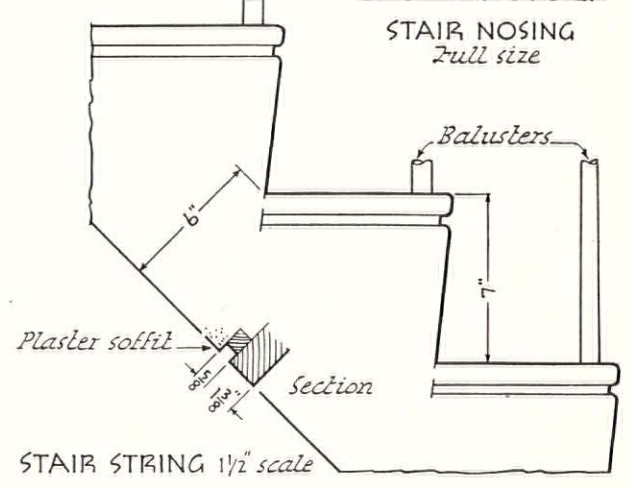
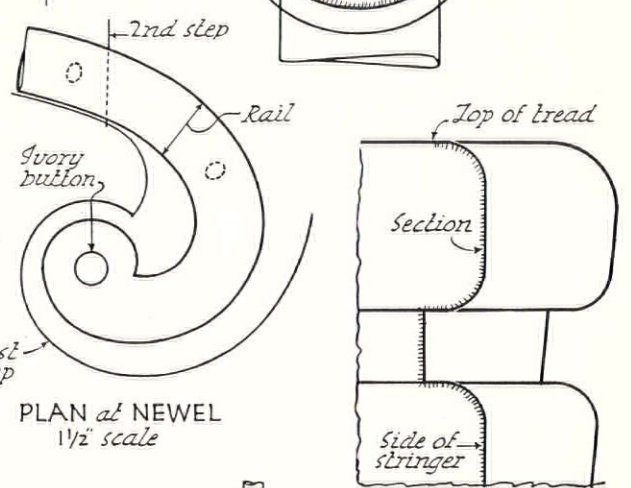
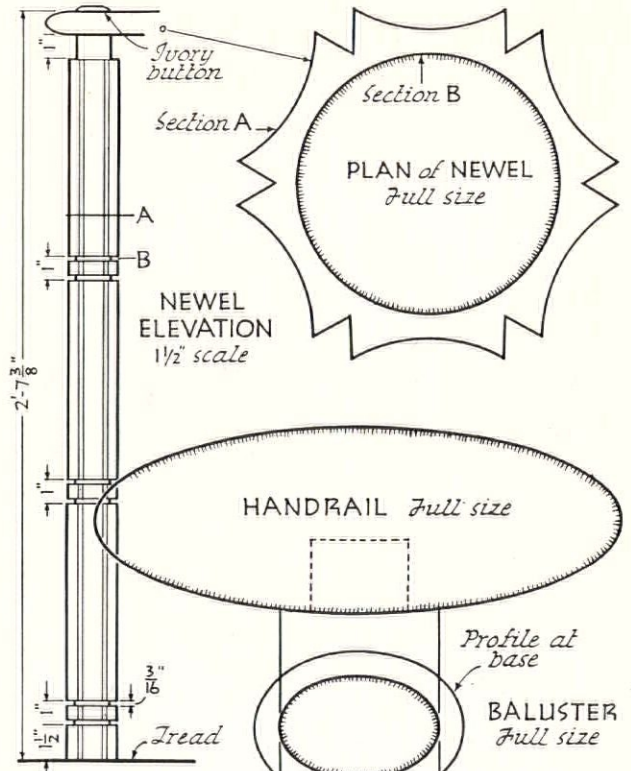

ERNEST A. GRUNSFELD, Jr. . . *Architect*

WALLACE F. YERKES. . . . ASSOCIATE

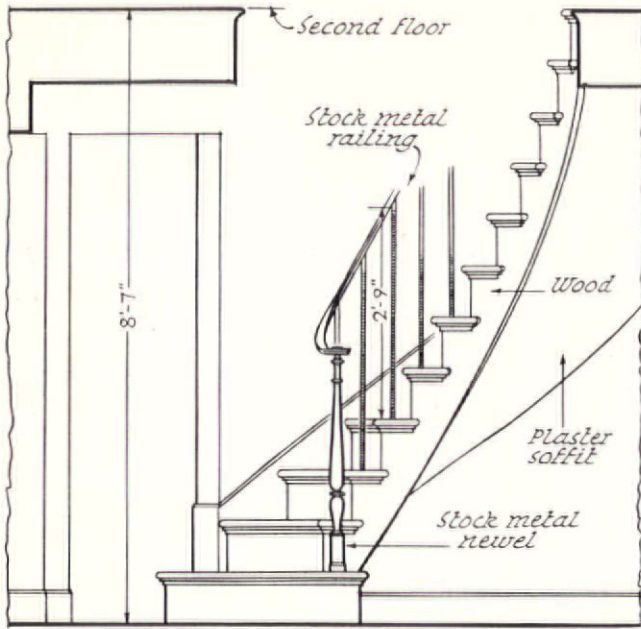

ELEVATION  $\frac{3}{8}$ " scale



RICHARD GARRISON

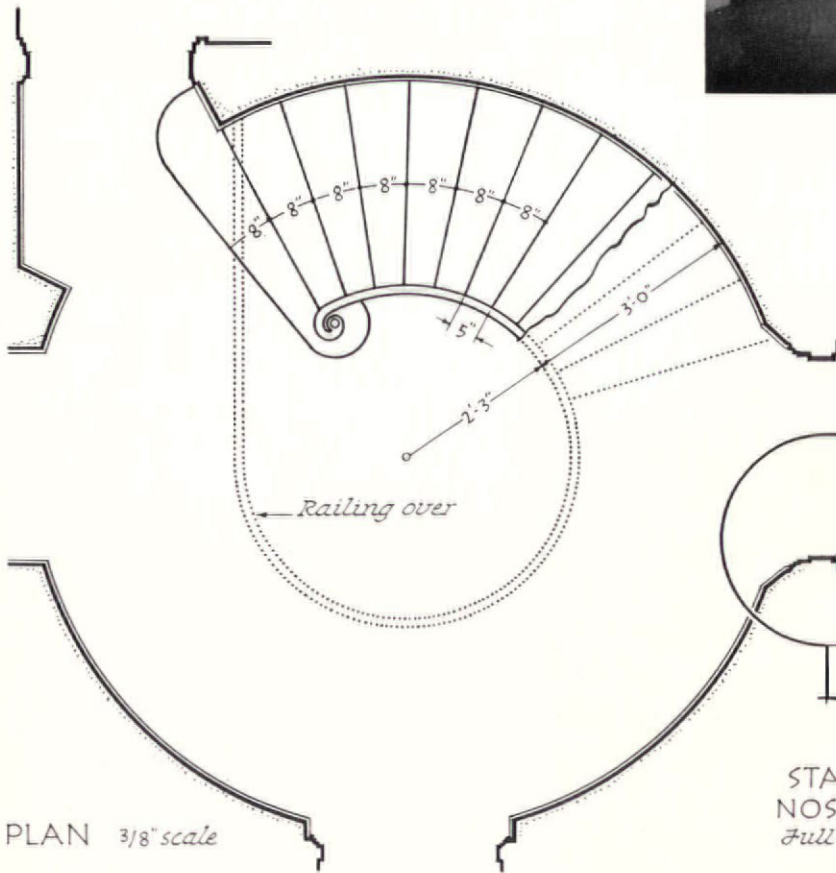

PLAN  $\frac{3}{8}$ " scale

HAND RAIL  
Full size

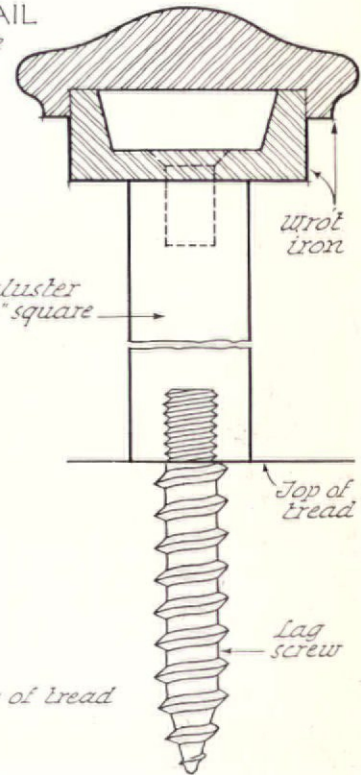

STAIR  
NOSING  
Full size

TALCOTT & TALCOTT . . . Architects

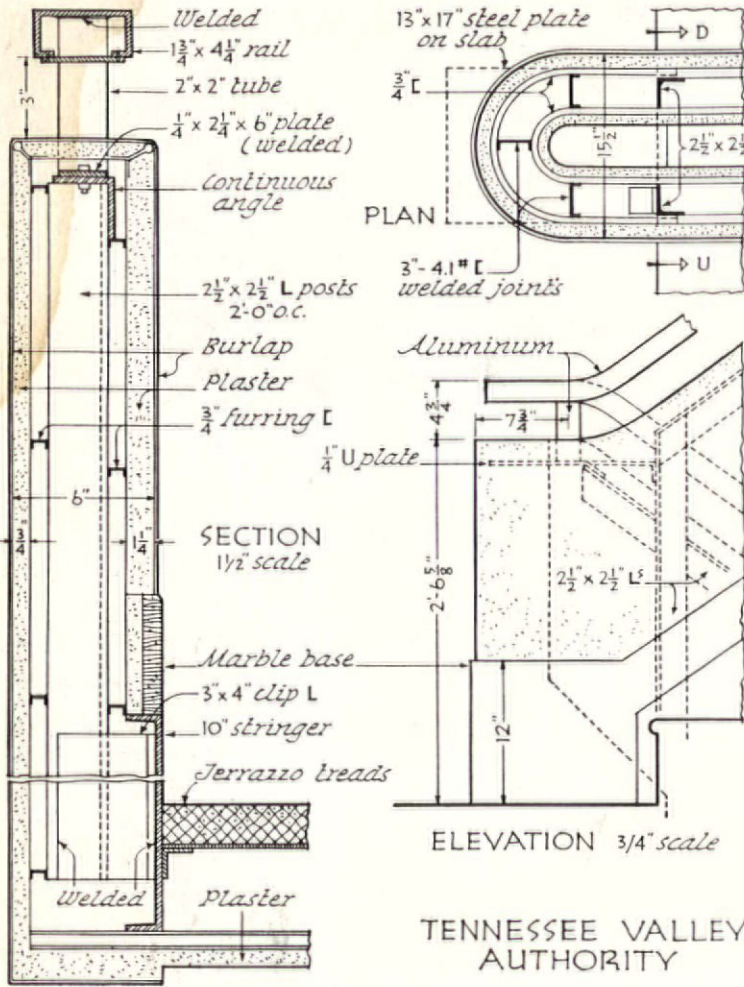

O'NEIL FORD & A. B. SWANK . . . . . Architects  
 Photo by MAX

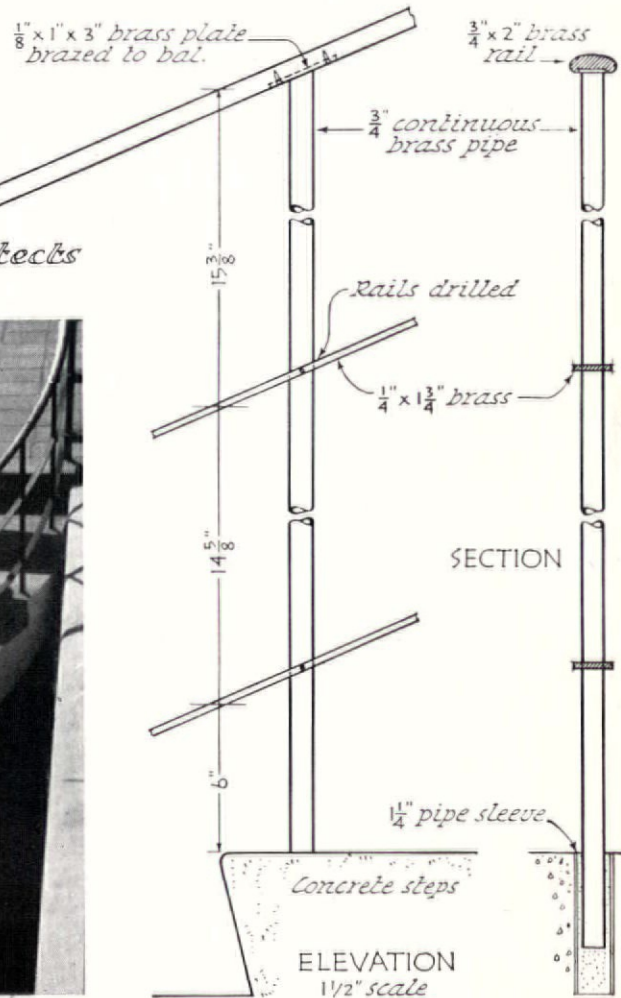
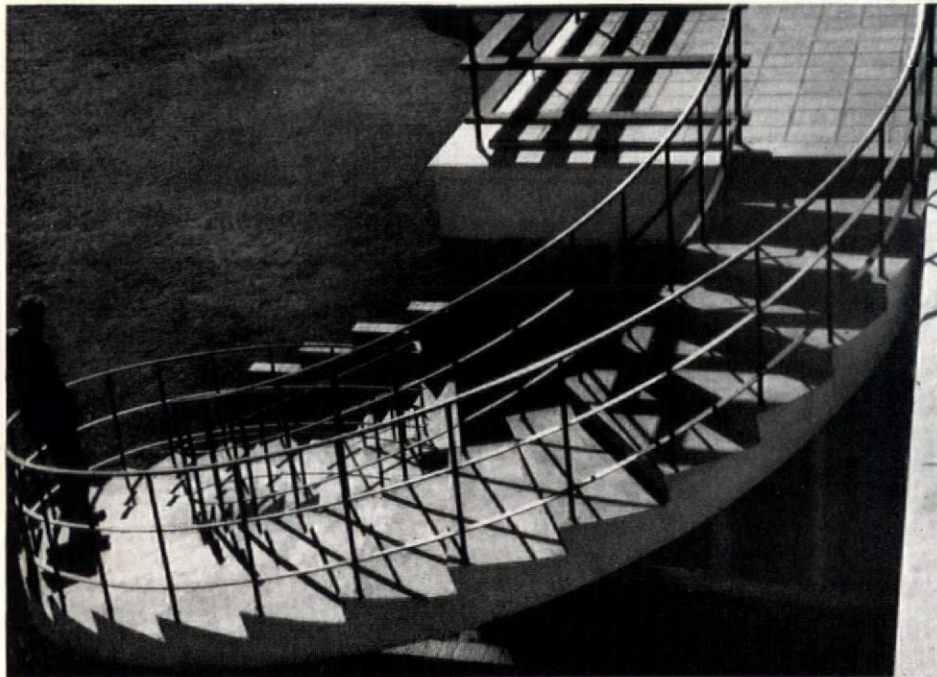



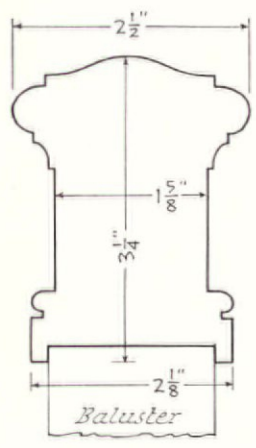
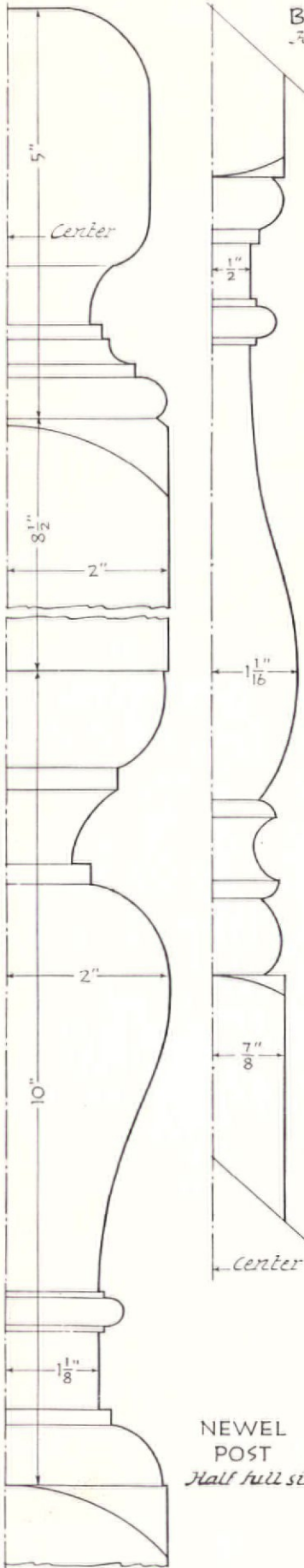

HANDRAIL  
*Half full size*

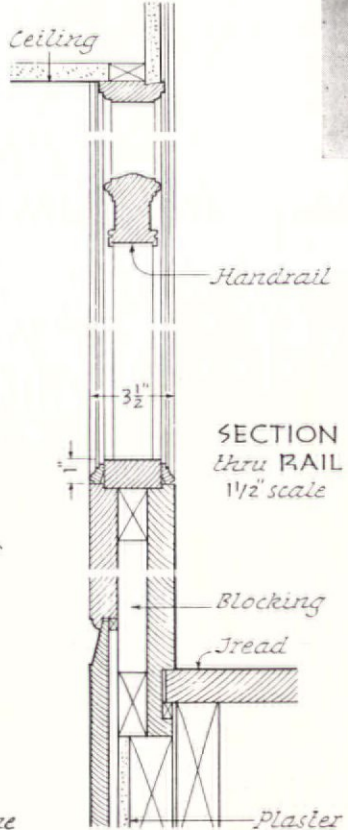

PANEL MOULD  
*Half full size*

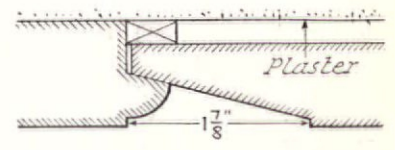

ELEVATION 1/4" scale

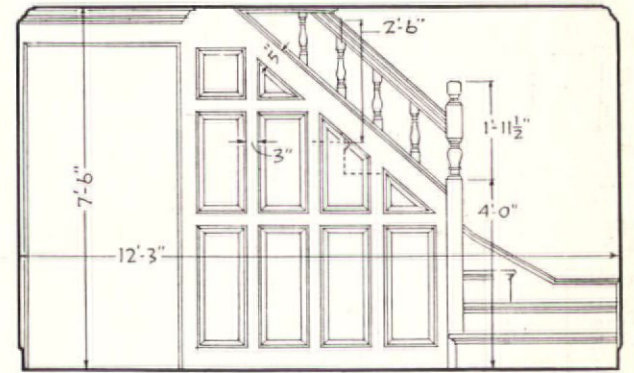

GEORGE H. VAN ANDA

FRANK J. FORSTER . . . . . Architect

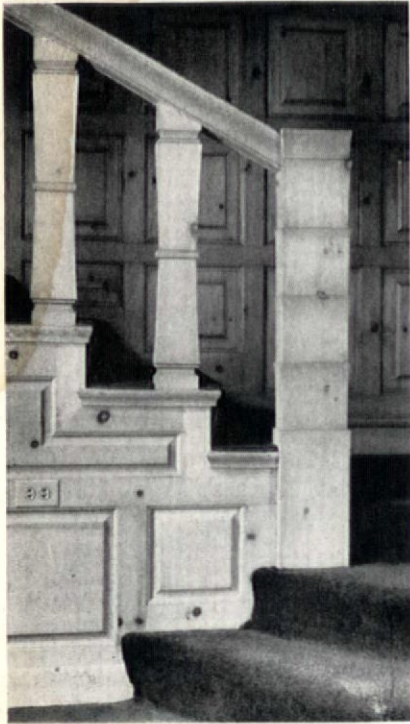

Photos by VAN ANDA  
LIVING RM

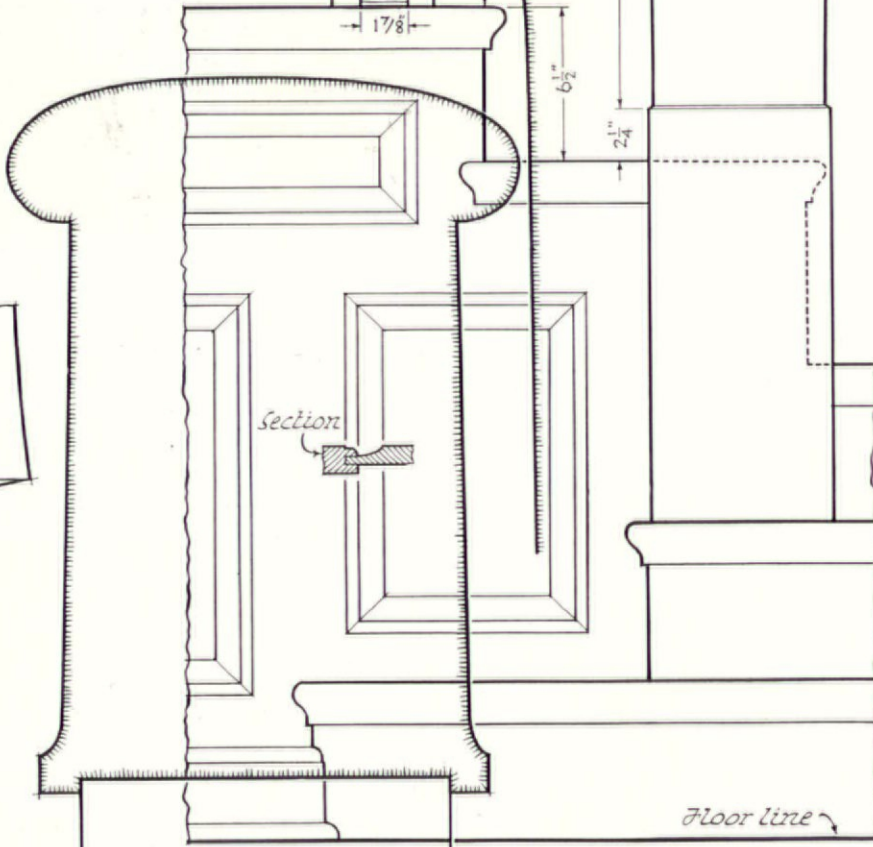
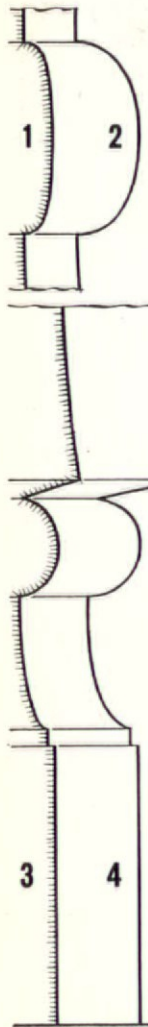
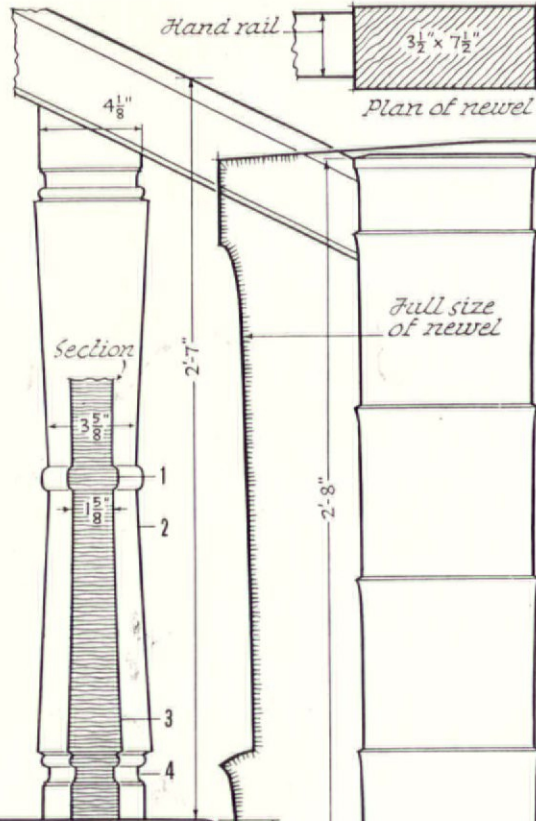

HAND RAIL Full size

ELEVATION of STAIRS  
1/2 scale

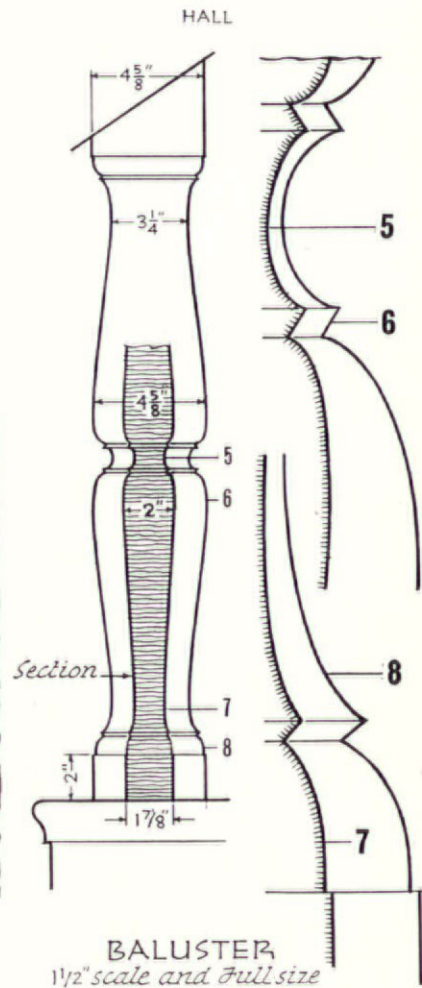

BALUSTER  
1/2 scale and Full size

BALUSTER  
Full size

WILLIAM GEHRON . . . . Architect

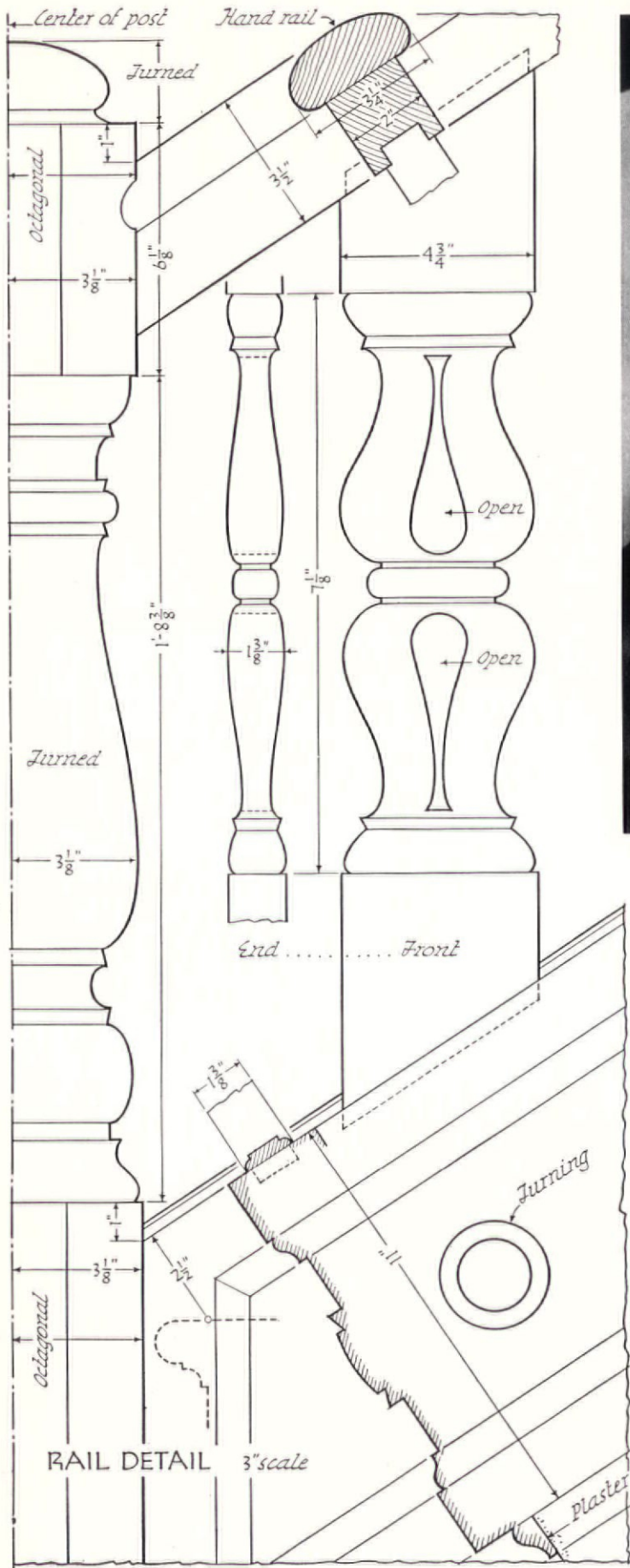

THE HUGHES CO

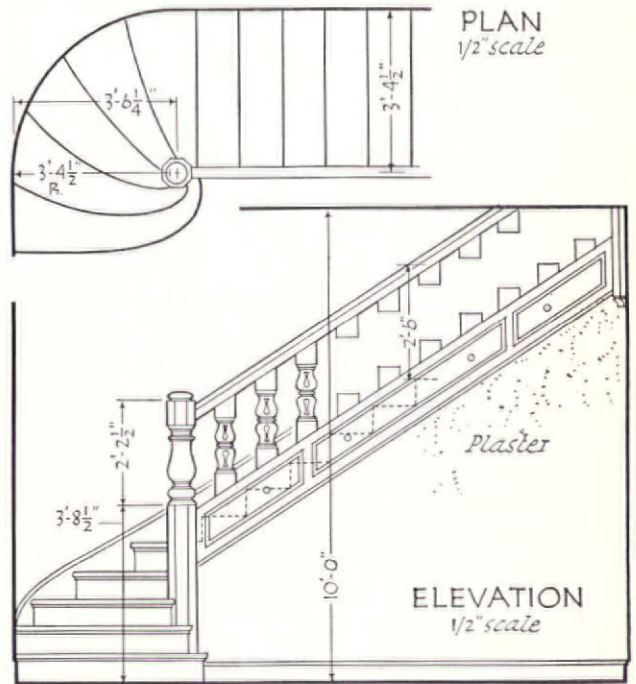

PRENTICE SANGER... Architect

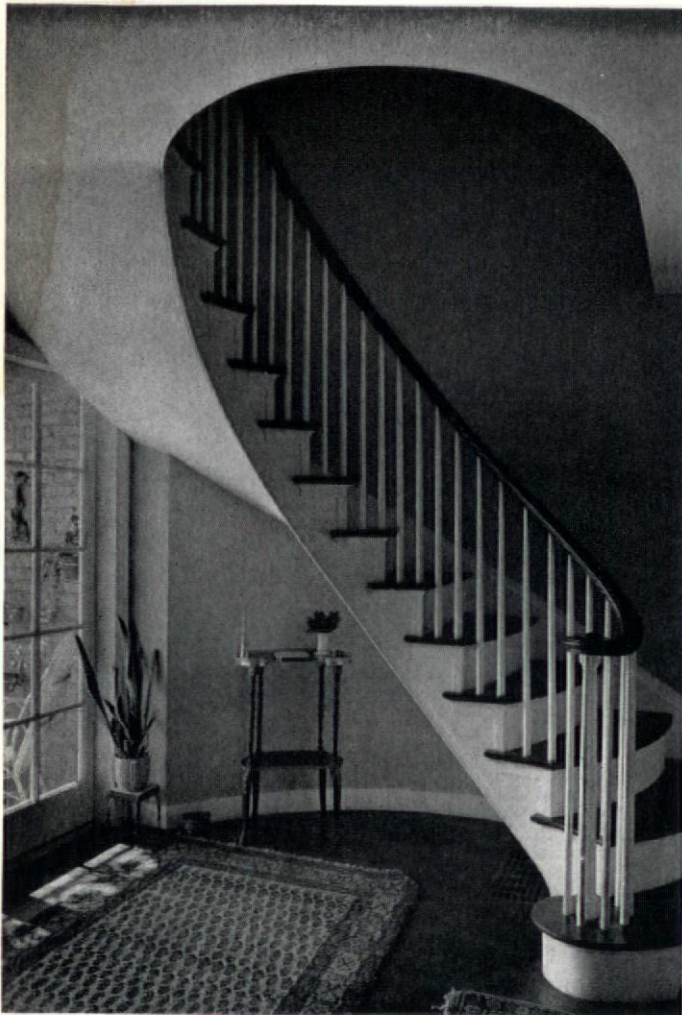

SAMUEL H. GOTTSCHO

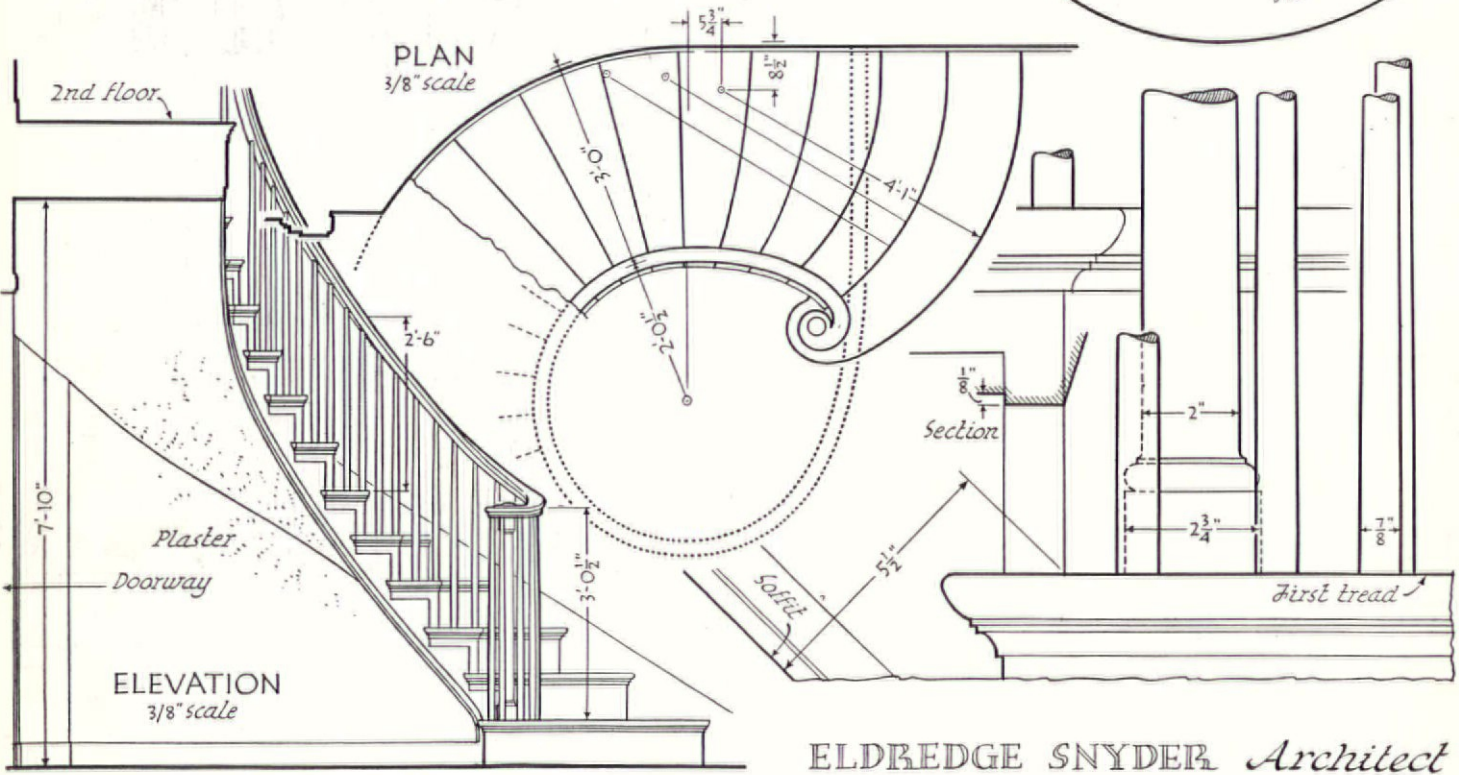
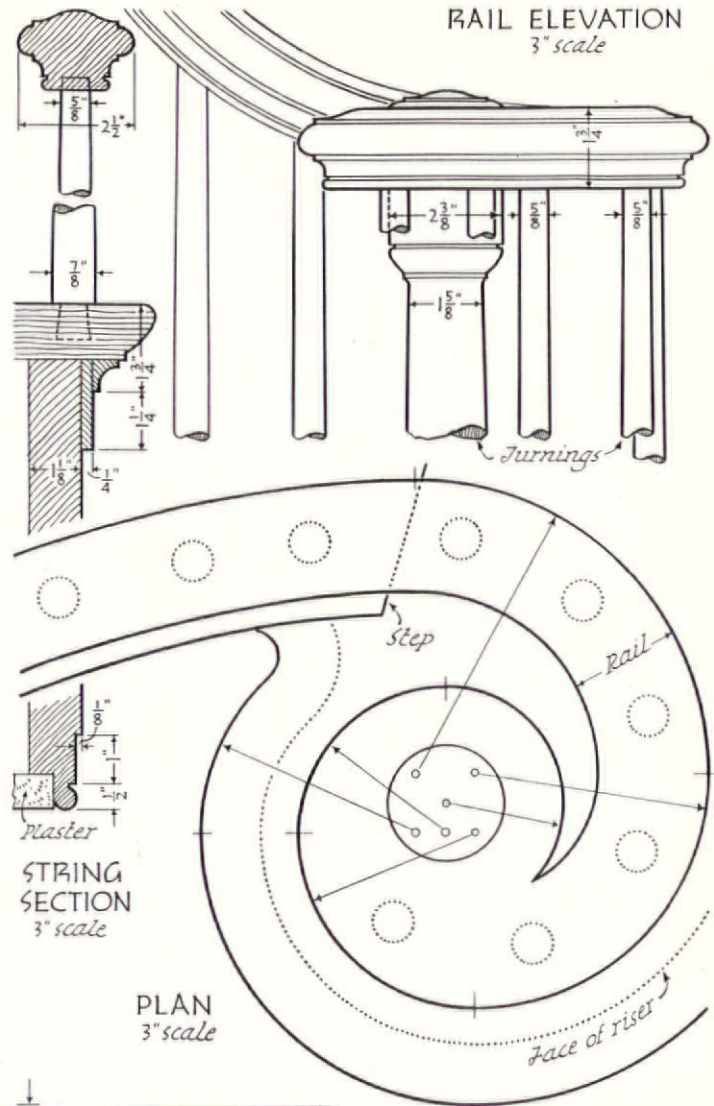

ELDRIDGE SNYDER *Architect*



F. S. LINCOLN

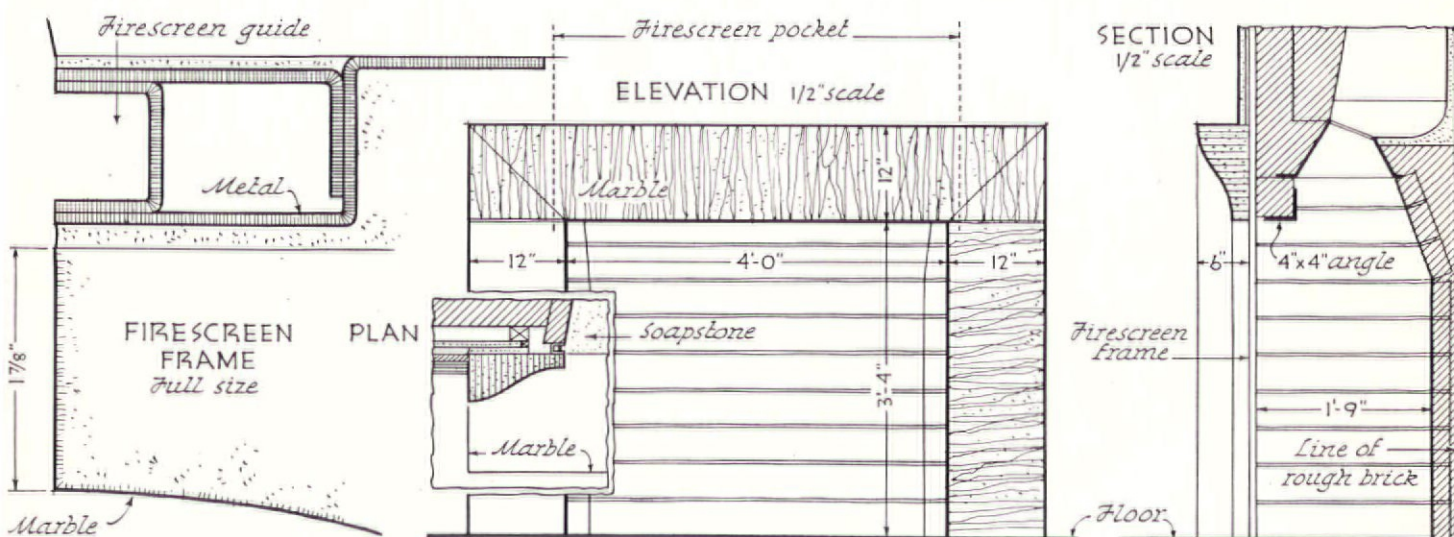

ERNEST A. GRUNSFELD, Jr. . . . *Architect*

WALLACE F. YERKES, . . . . ASSOCIATE



F. S. LINCOLN

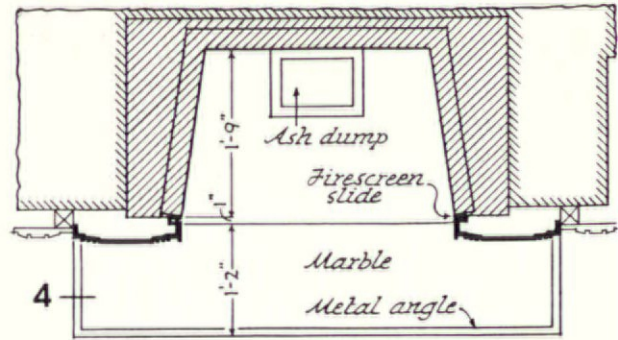

PLAN 1/2" scale

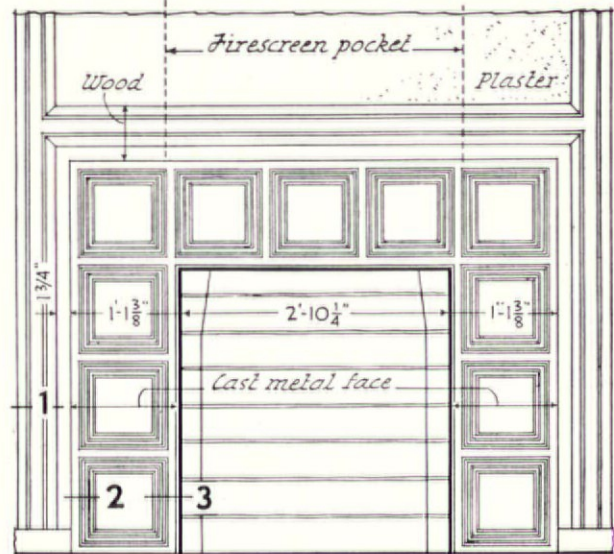

ELEVATION 1/2" scale

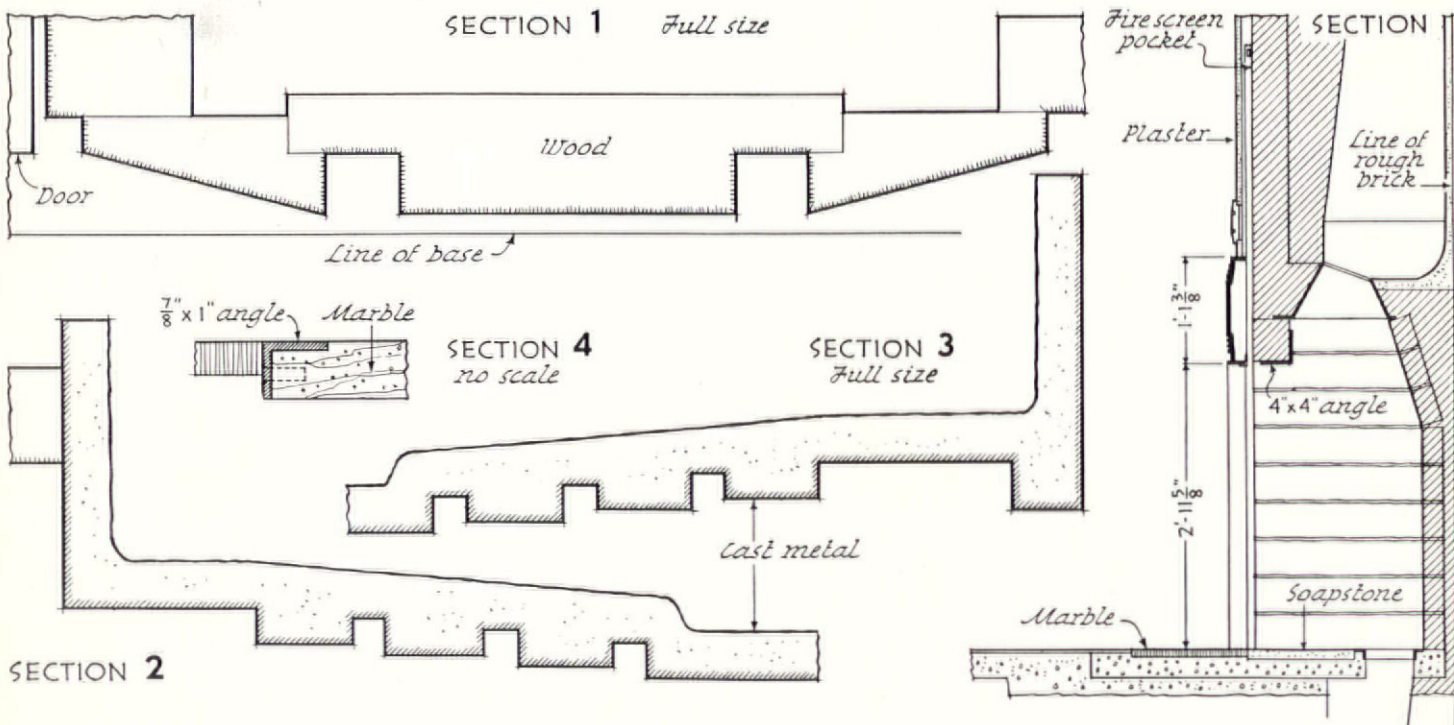

SECTION 2

ERNEST A. GRUNSFELD, Jr. . . . *Architect*

WALLACE F. YERKES, . . . . ASSOCIATE

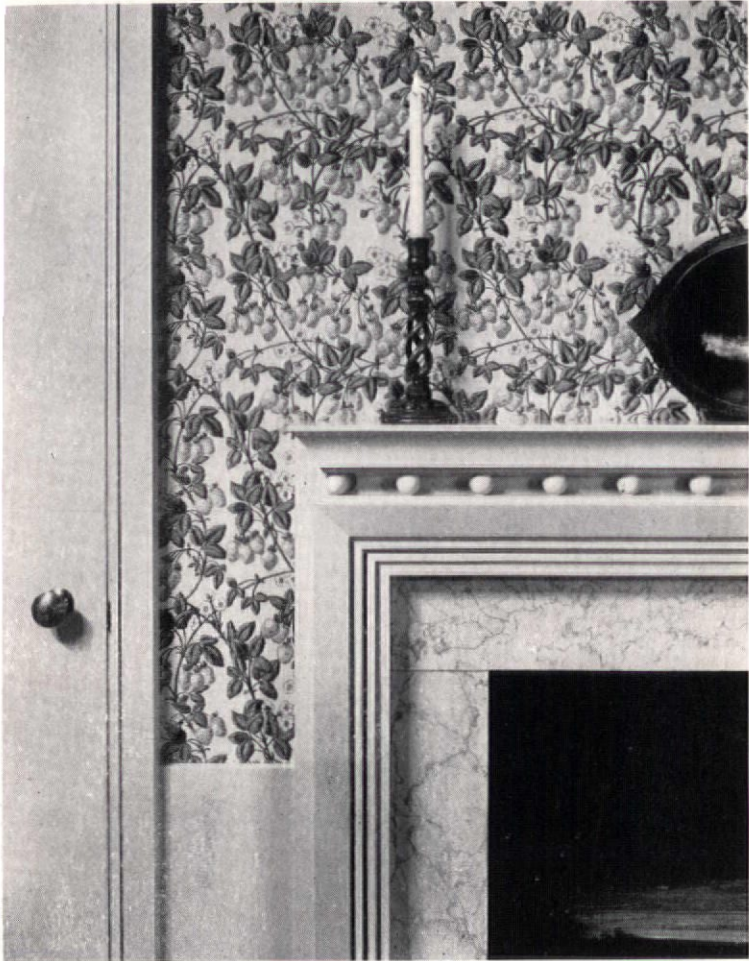

F. S. LINCOLN

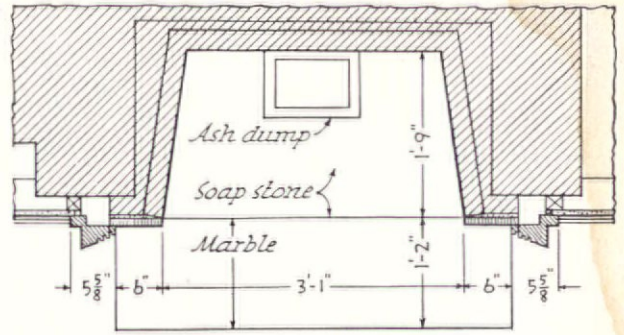

PLAN 1/2" scale

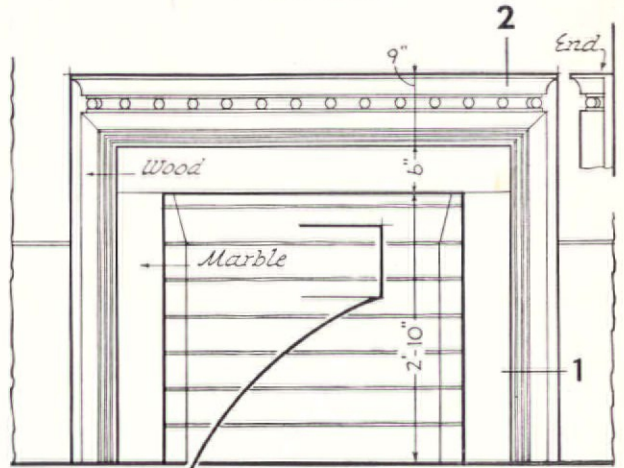

ELEVATION 1/2" scale

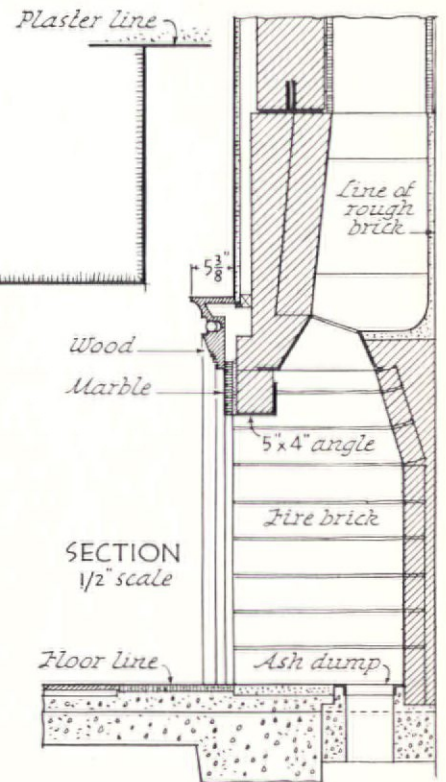
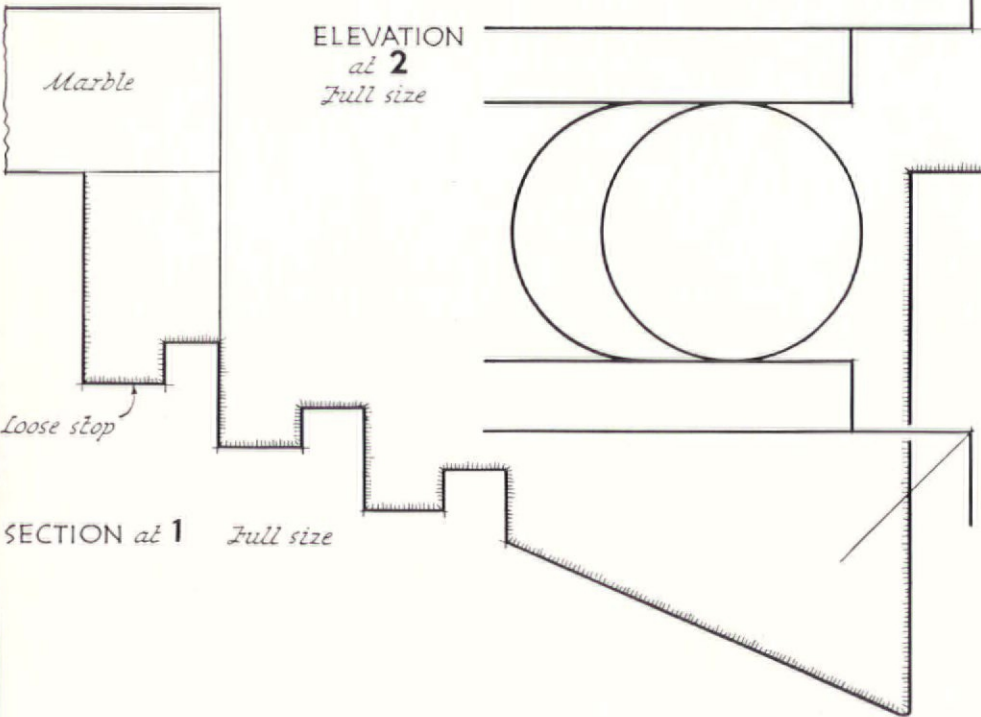

ERNEST A. GRUNSFELD, Jr. . . Architect

WALLACE F. YERKES . . . ASSOCIATE

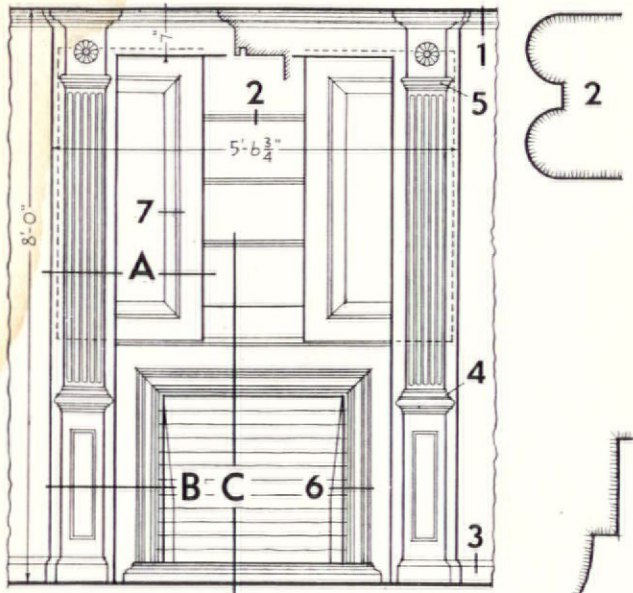

ELEVATION  $\frac{3}{8}$ " scale



RICHARD GARRISON

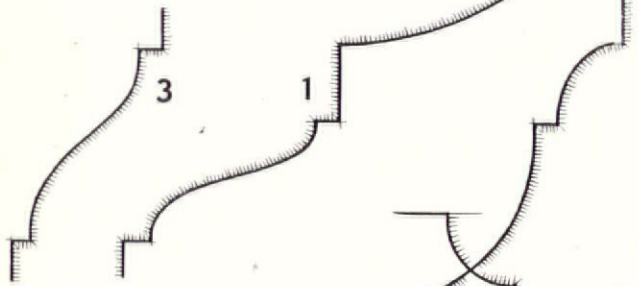

SECTION C

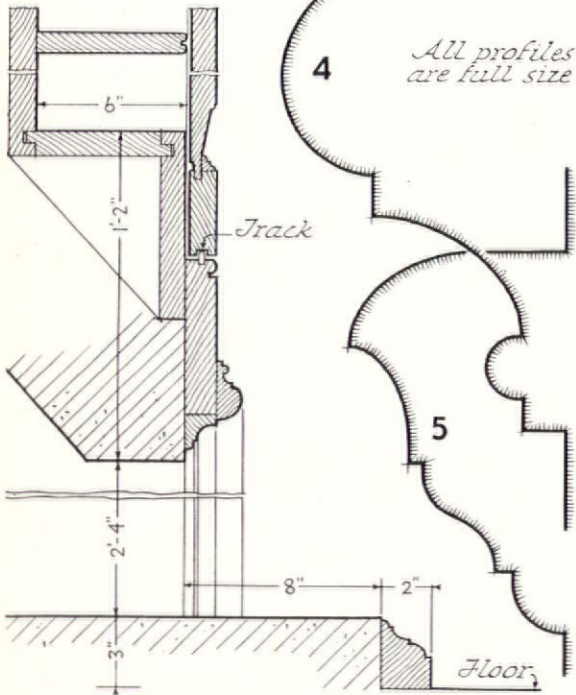

*All profiles are full size*

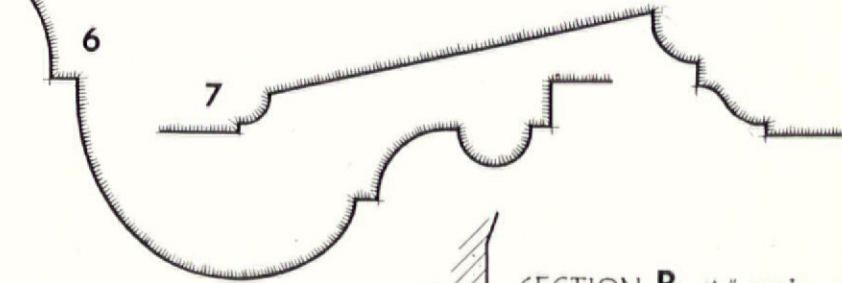

SECTION B  $1\frac{1}{2}$ " scale

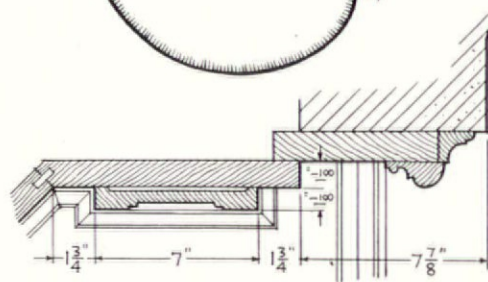

SECTION A  $1\frac{1}{2}$ " scale

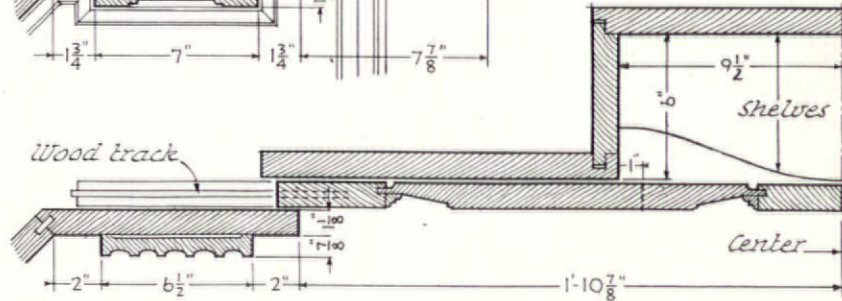

TALCOTT & TALCOTT . . . . . Architects





F. S. LINCOLN

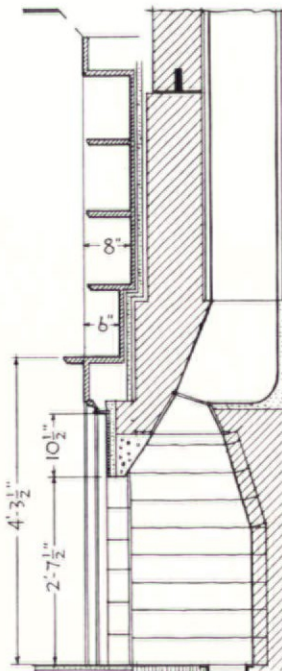
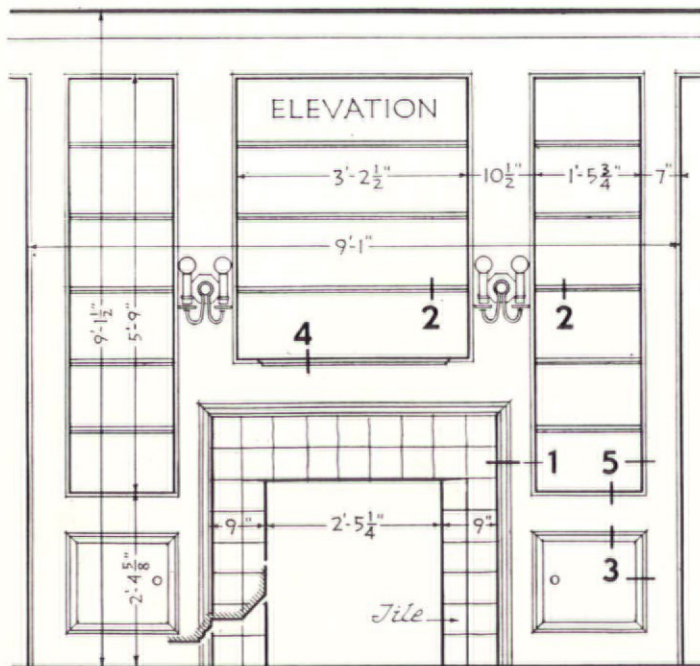
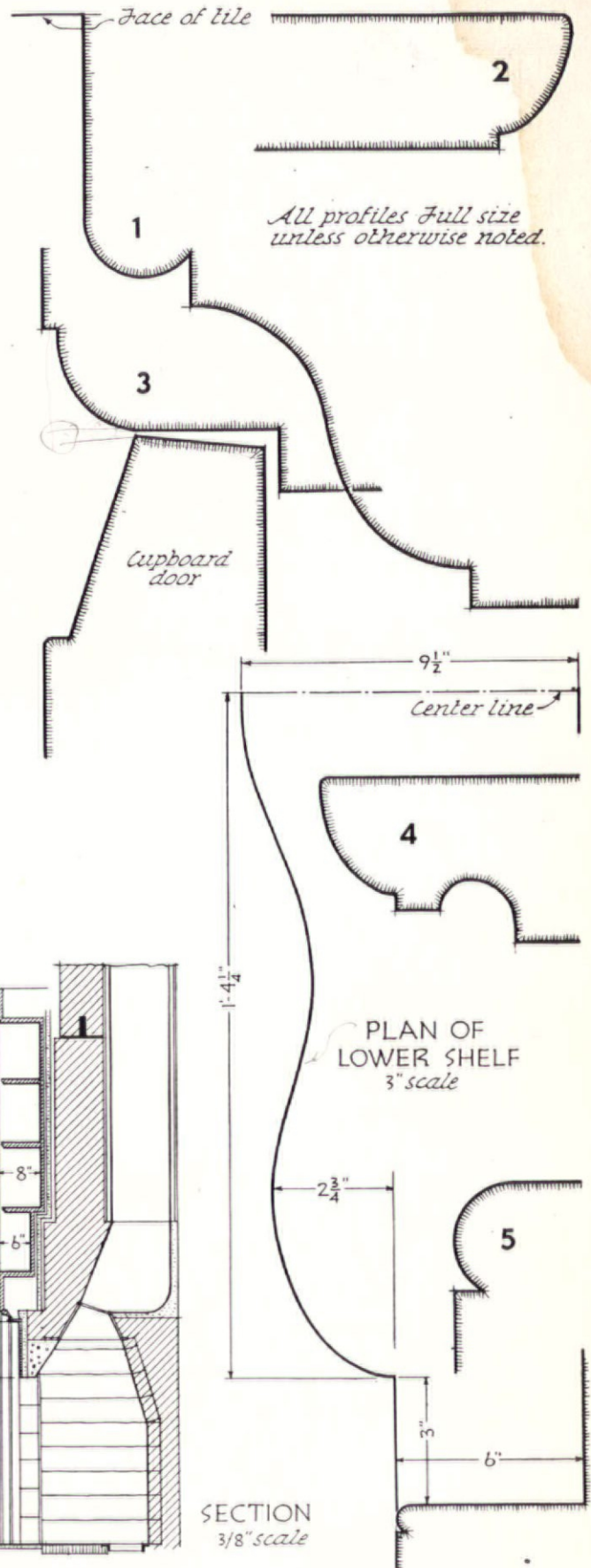

ERNEST A. GRUNSFELD, Jr. . Architect

WALLACE F. YERKES. . . ASSOCIATE

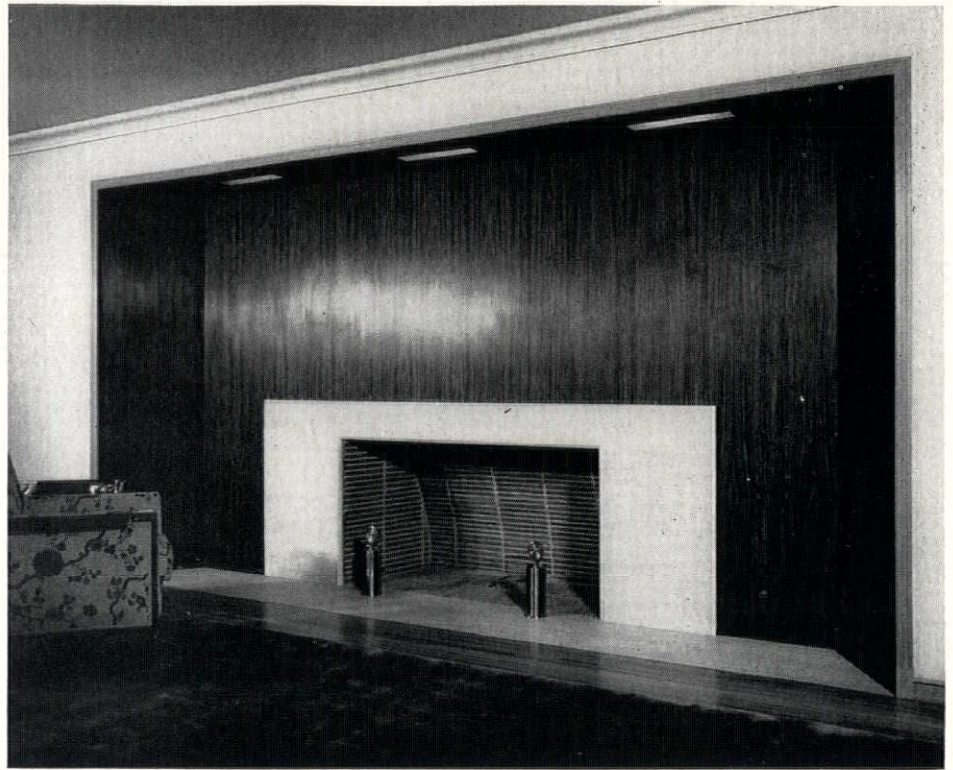
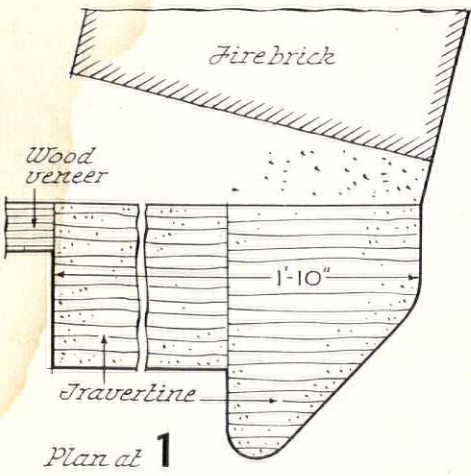

JULIUS SHULMAN

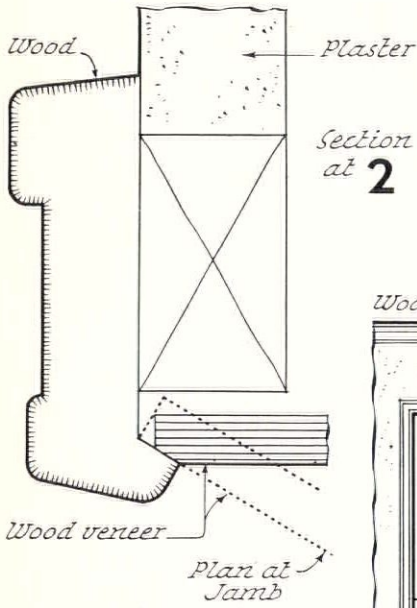

SECTIONS at FULL SIZE

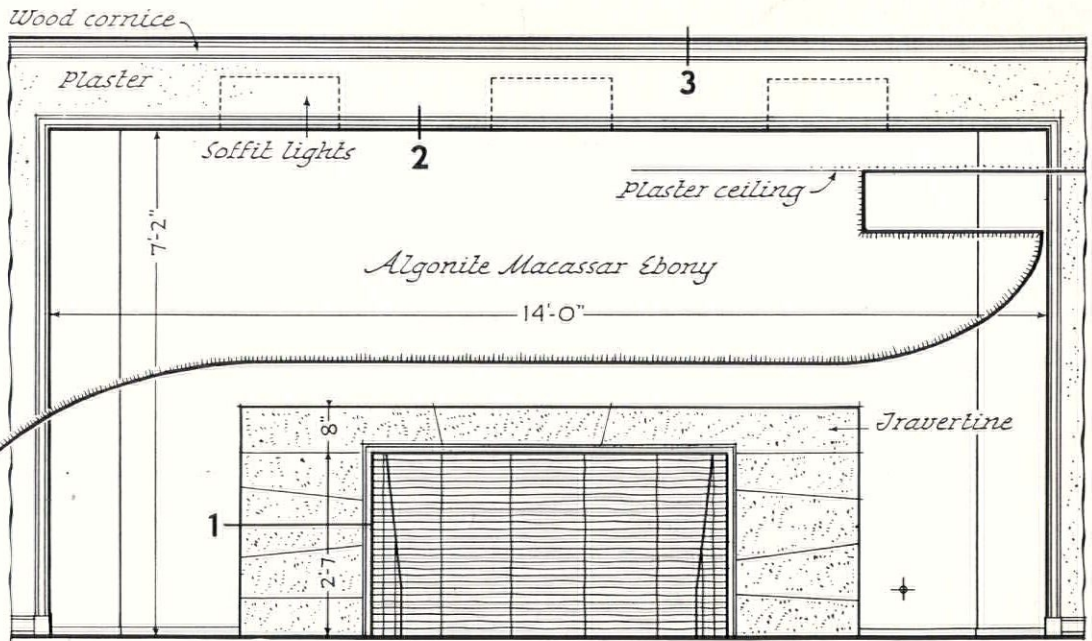

ELEVATION  
3/8" scale

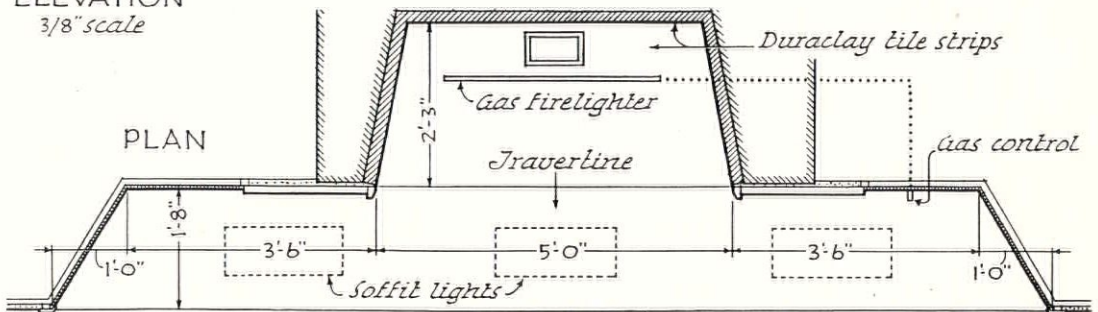
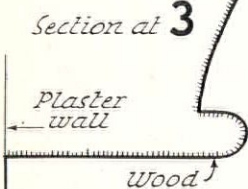

PAUL LASZLO  
Designer

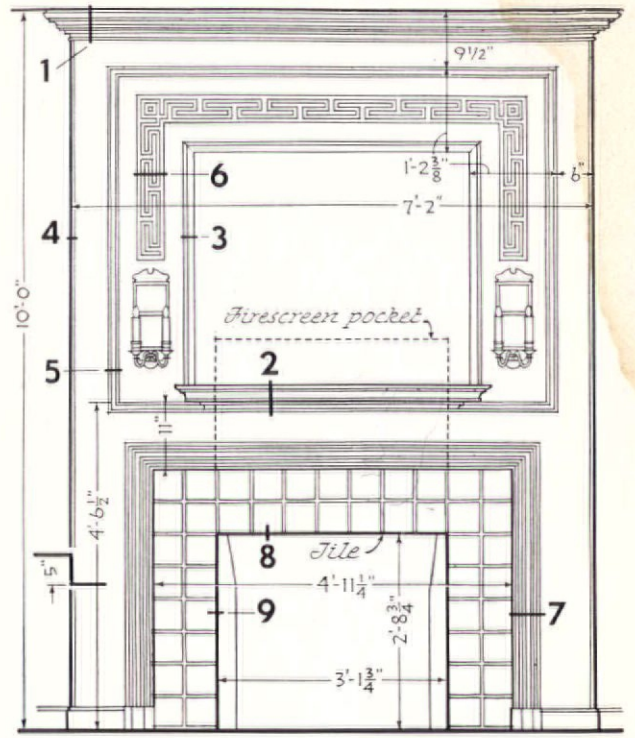
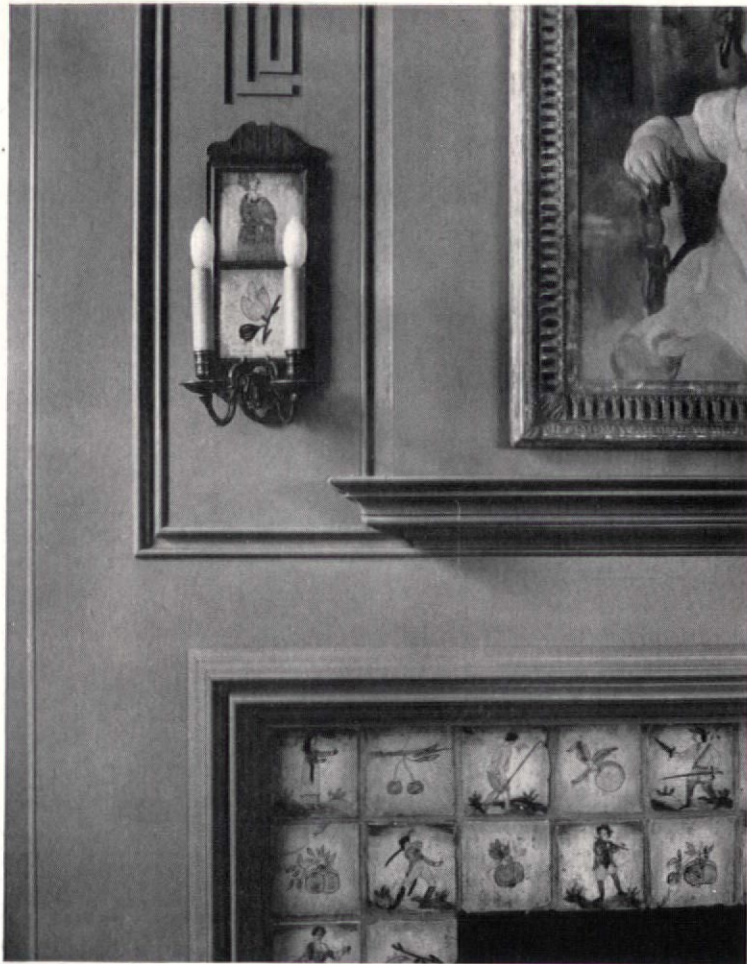

ELEVATION 3/8" scale

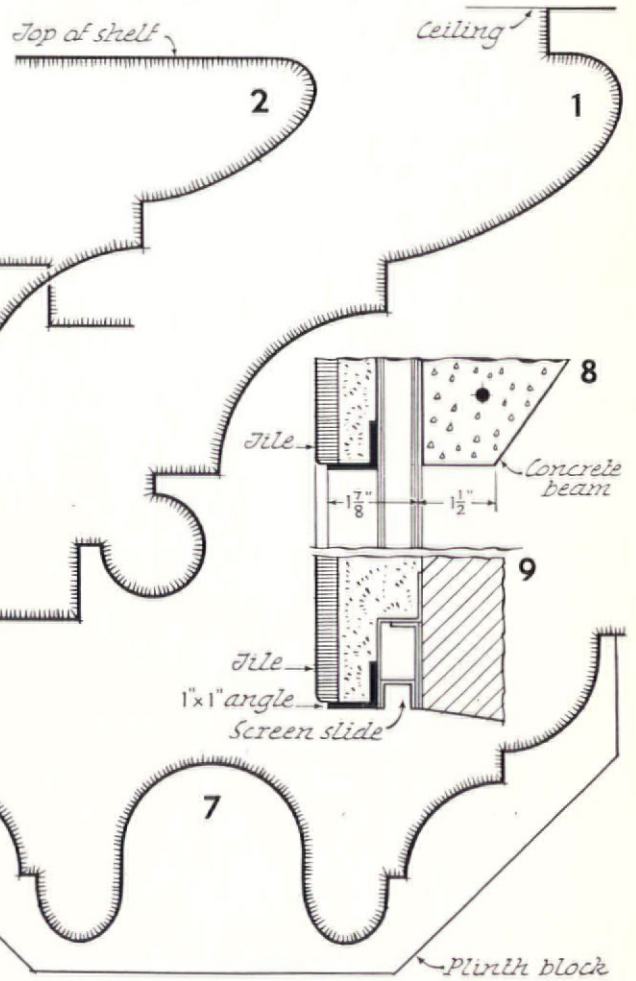

F. S. LINCOLN

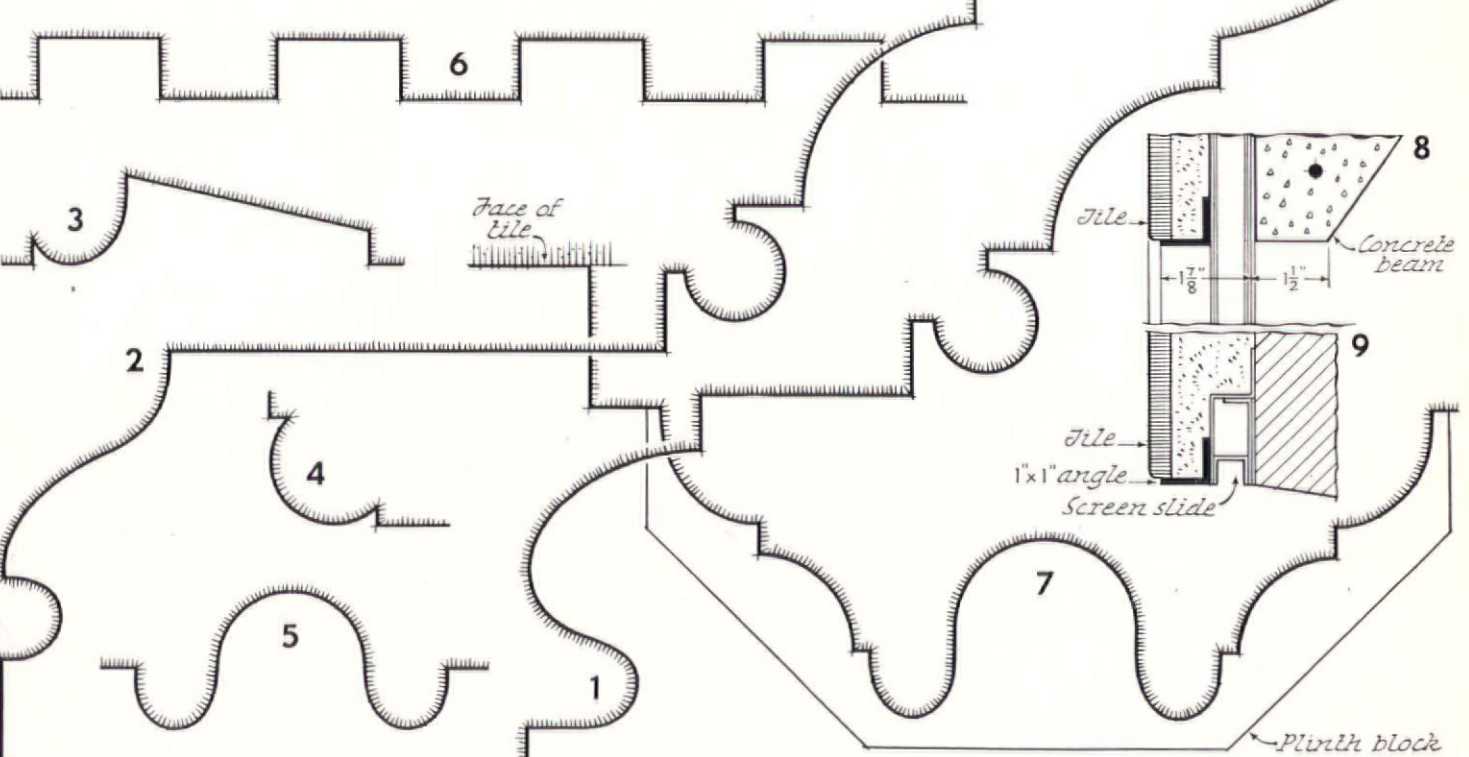

ERNEST A. GRUNSFELD, Jr. . . Architect WALLACE F. YERKES . . . ASSOCIATE

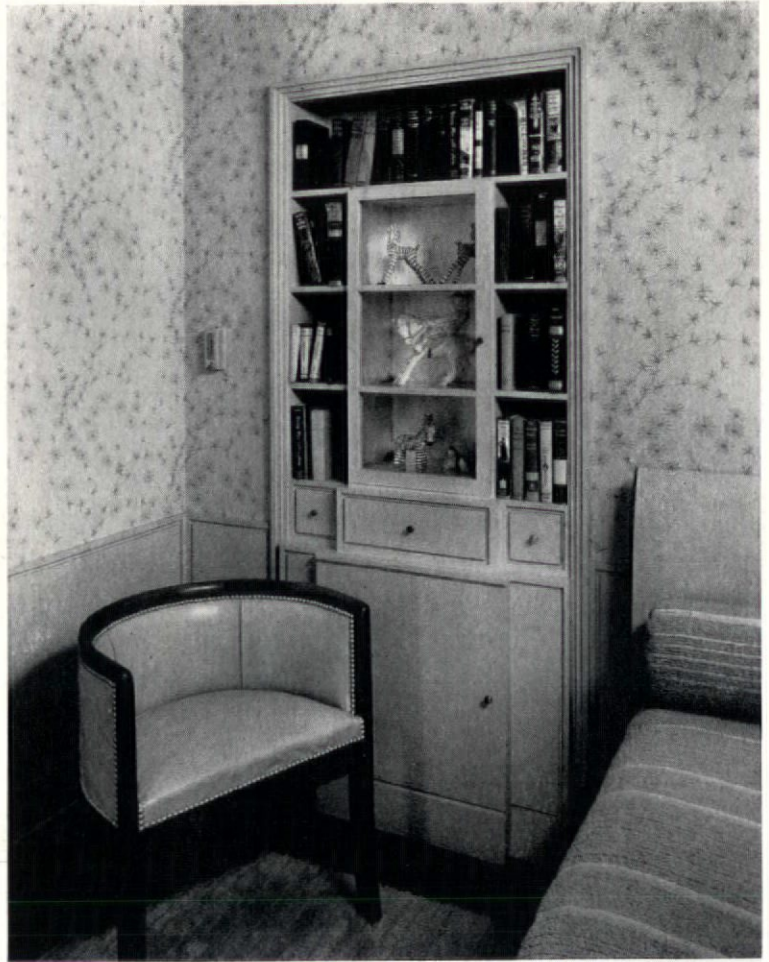
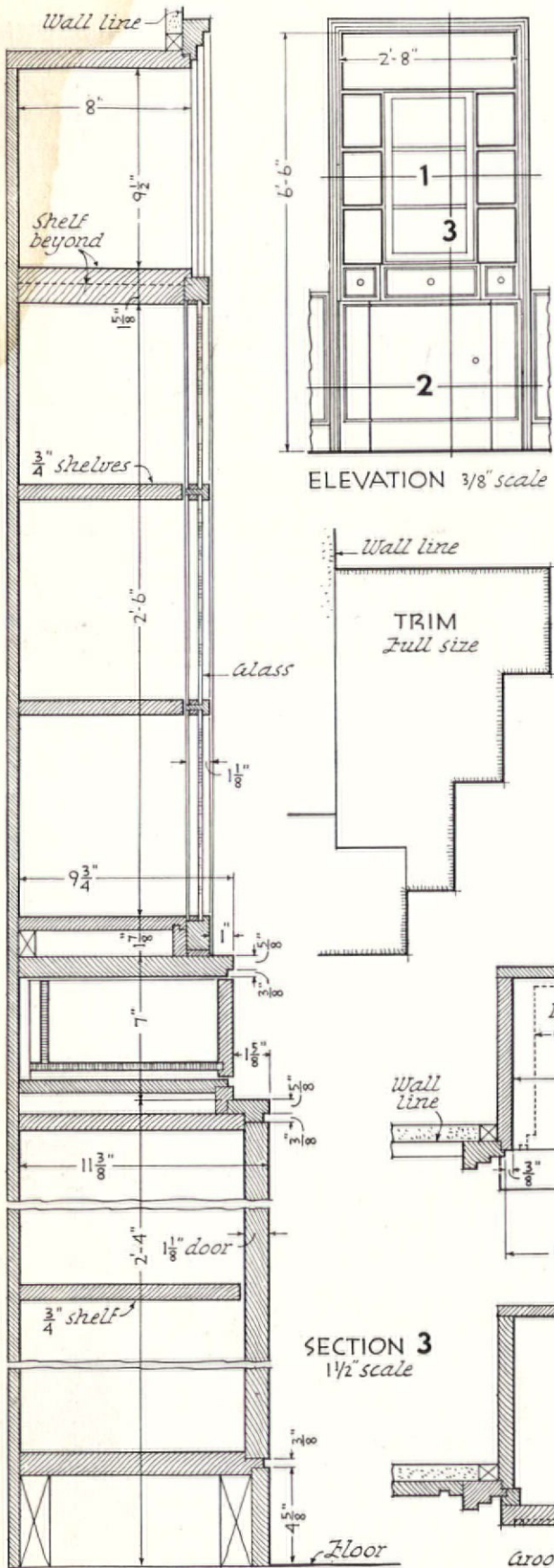

F. S. LINCOLN

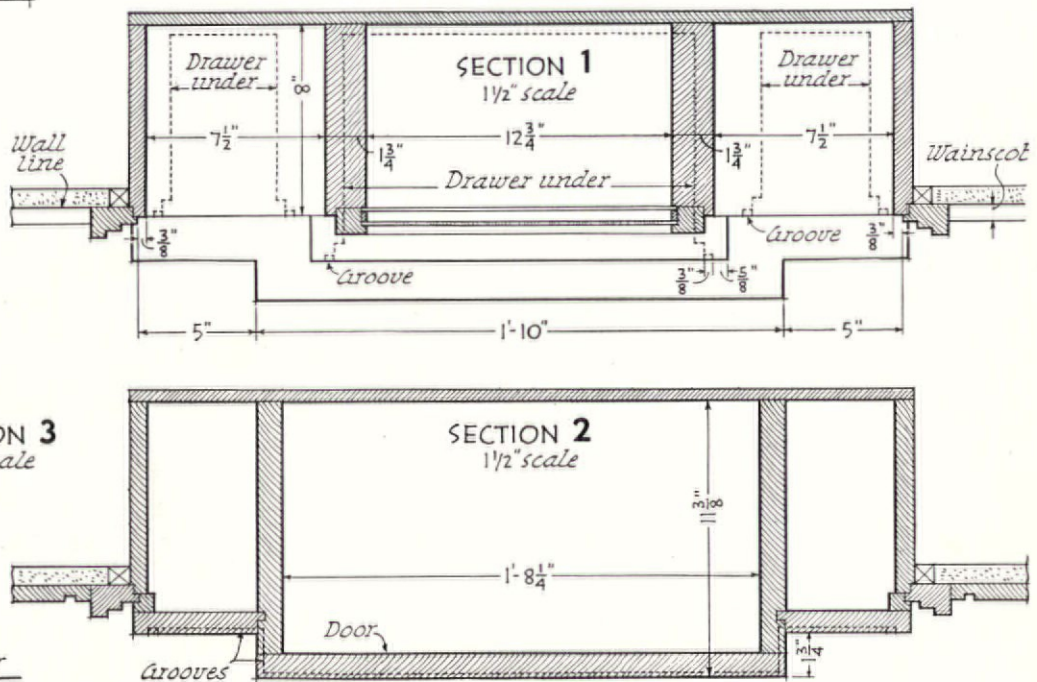

ERNEST A. GRUNSFELD, Jr. . . Architect

WALLACE F. YERKES, . . . ASSOCIATE

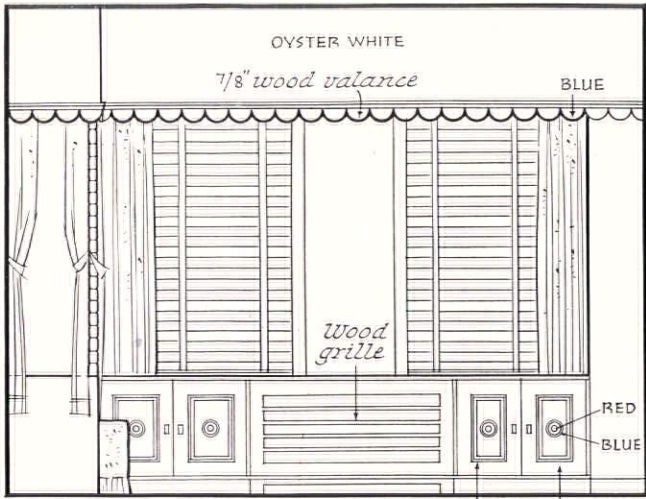

ELEVATION towards 2

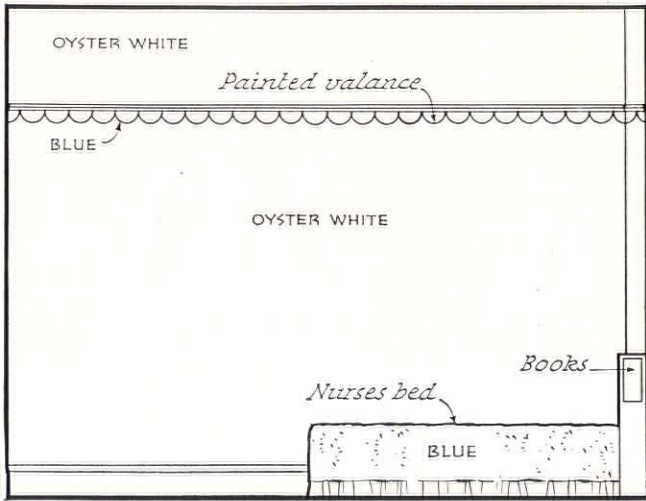

ELEVATION towards 4

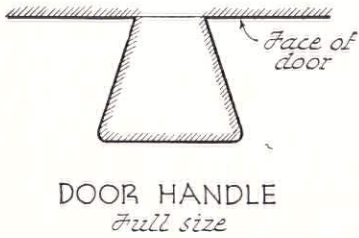

PLAN 1/4" scale

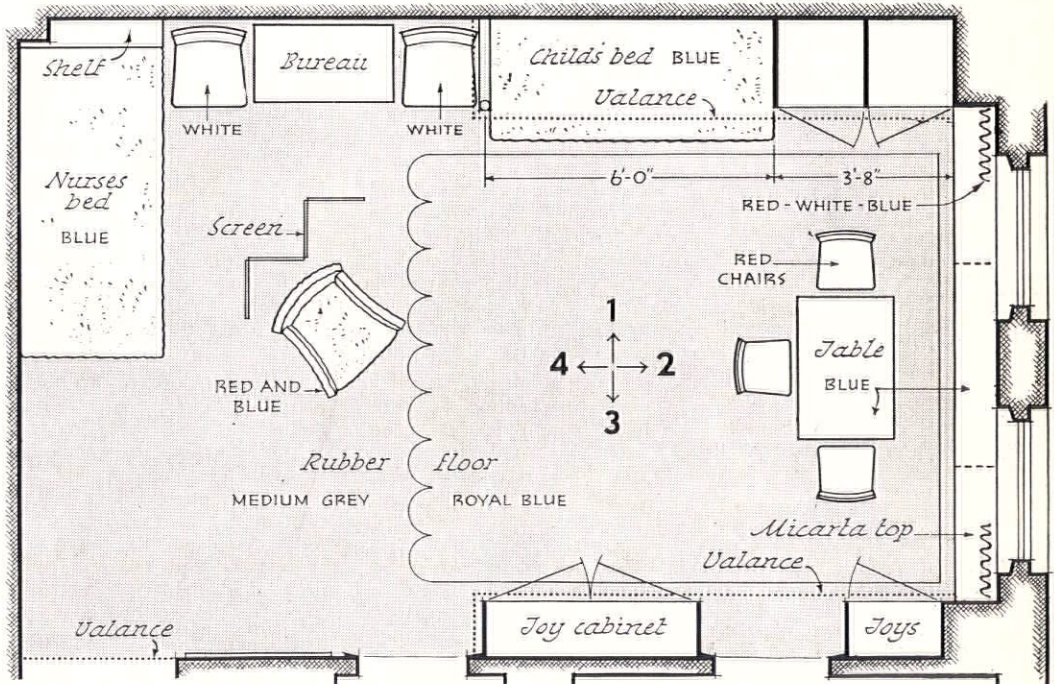

ROBERT M. DAMORA

JOSEPH DOUGLAS WEISS  
*Architect*

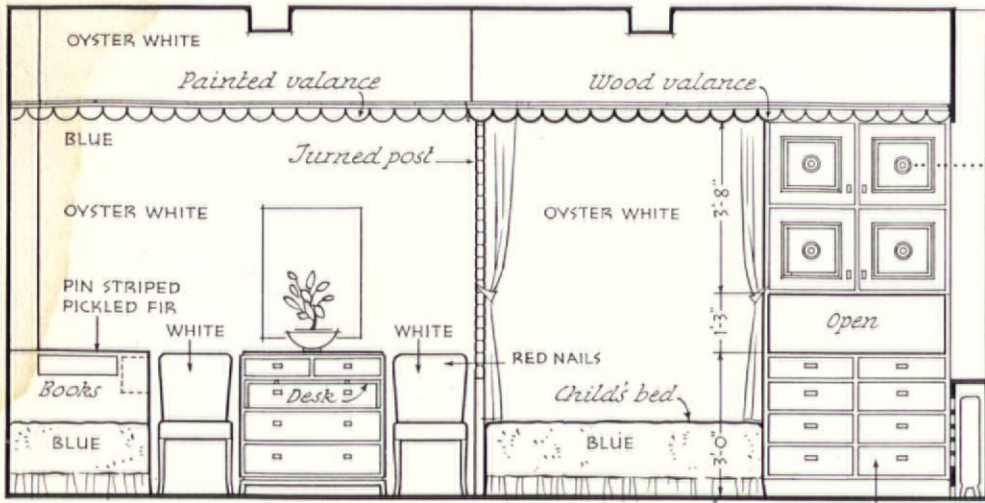

ELEVATION towards 1

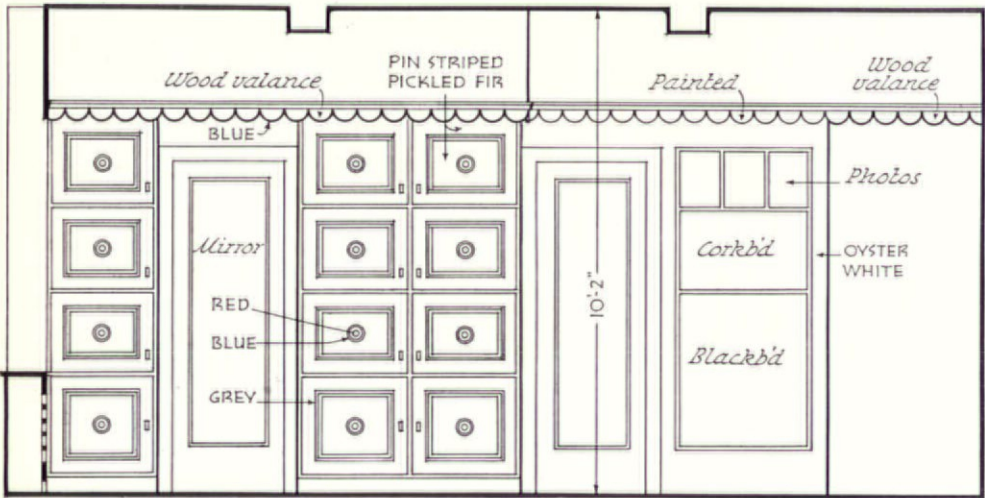
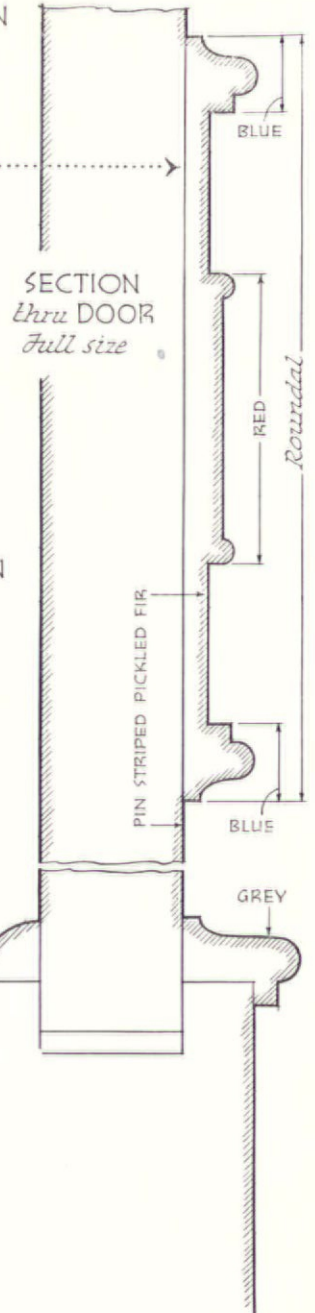

ELEVATION towards 3

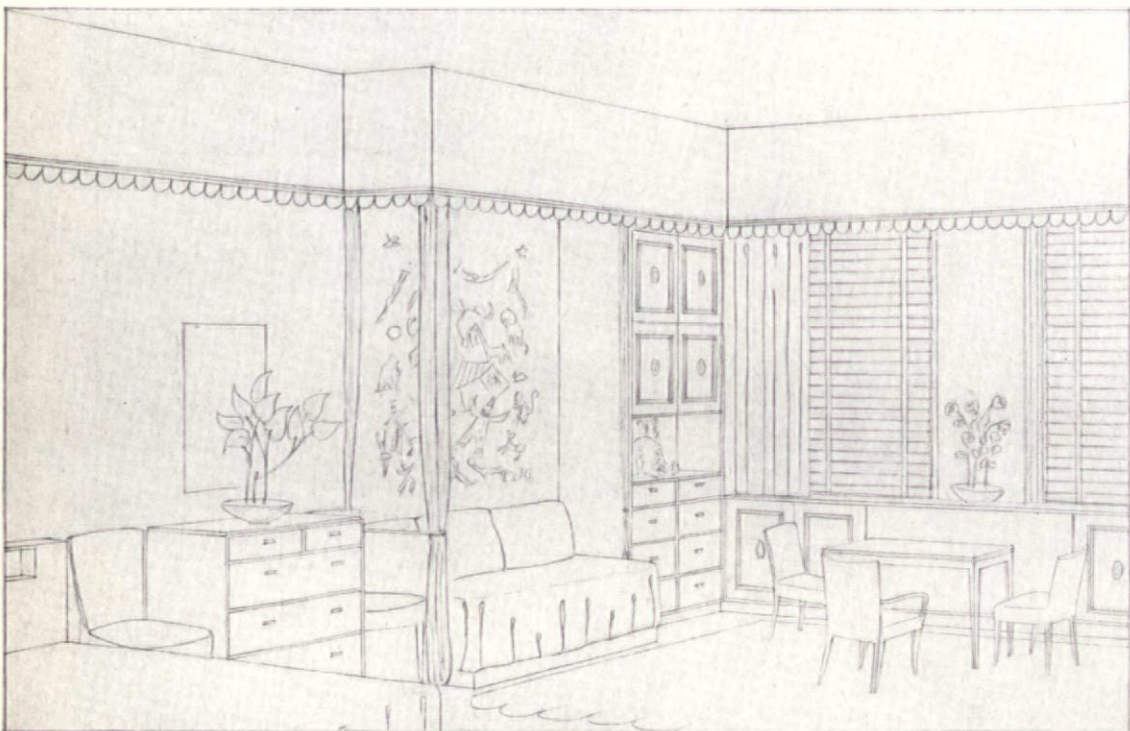

Architect's original drawing

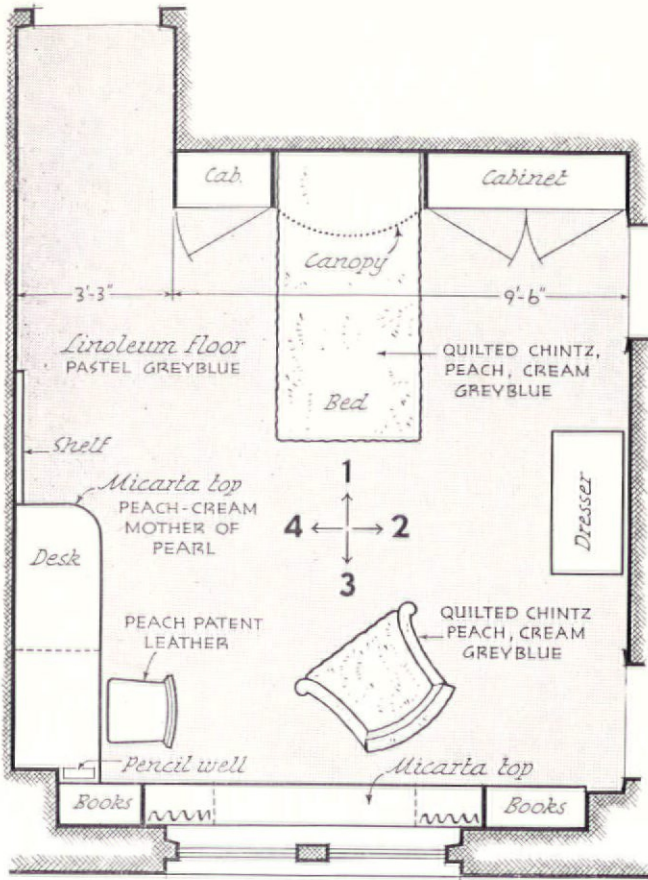

PLAN 1/4" scale



ROBERT M. DAMORA

ELEVATION towards 1 1/4" scale

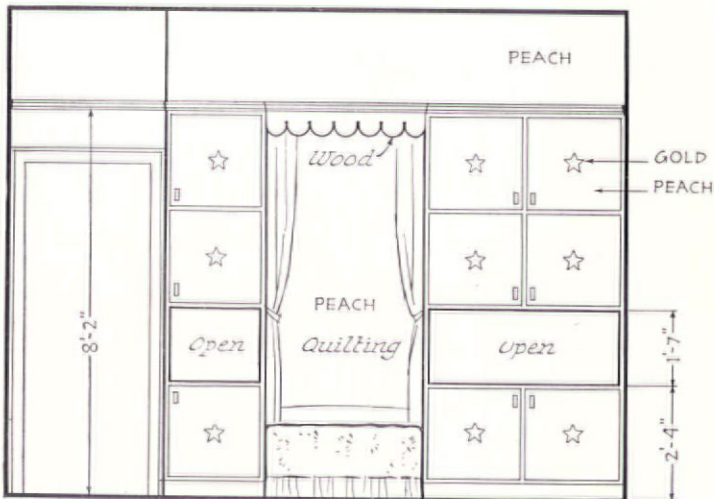

ELEVATION towards 2

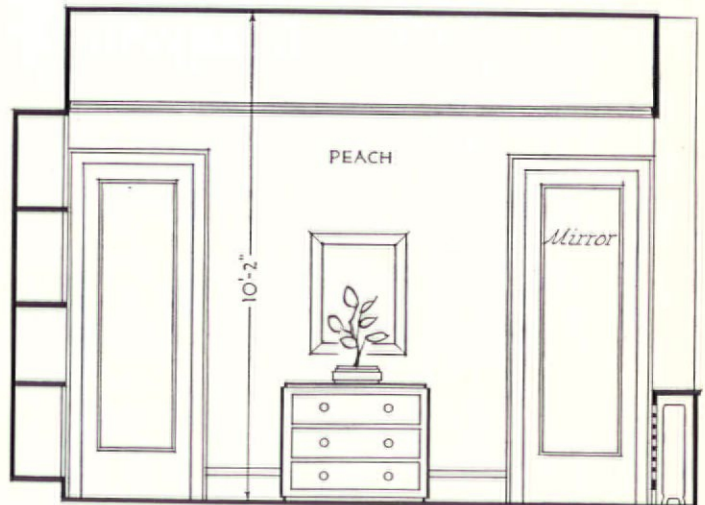

JOSEPH DOUGLAS WEISS . . . . . Architect

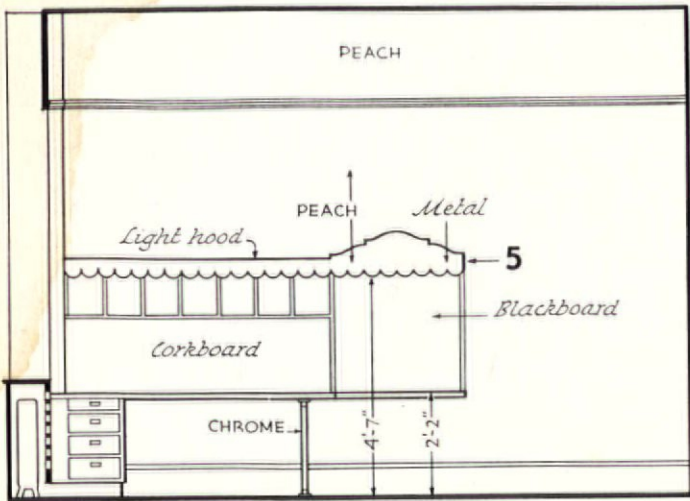

ELEVATION towards 4 1/4" scale

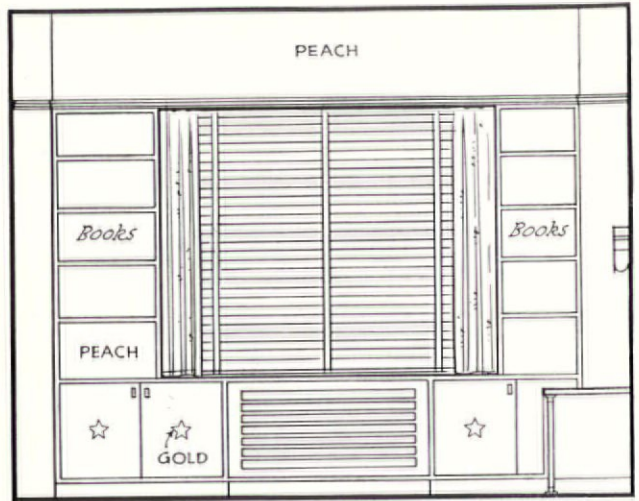

ELEVATION towards 3

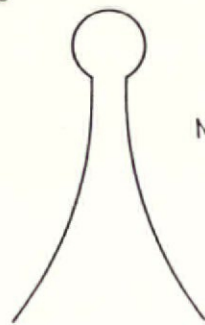

METAL VALANCE  
Full size

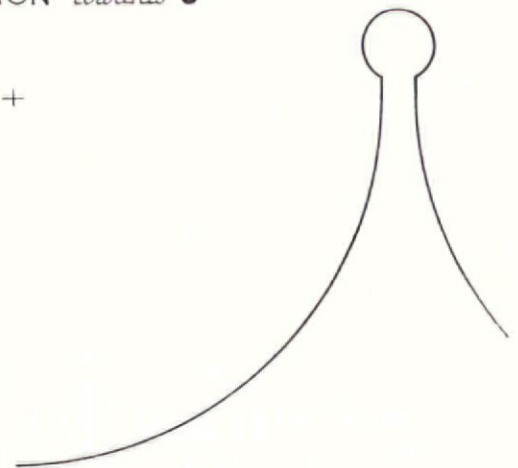

ROBERT M. DAMORA



ELEVATION  
at 5  
3" scale

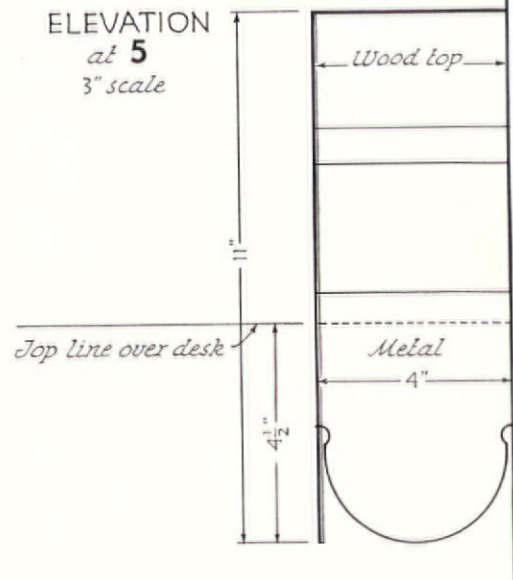

JOSEPH DOUGLAS WEISS . . . . . Architect



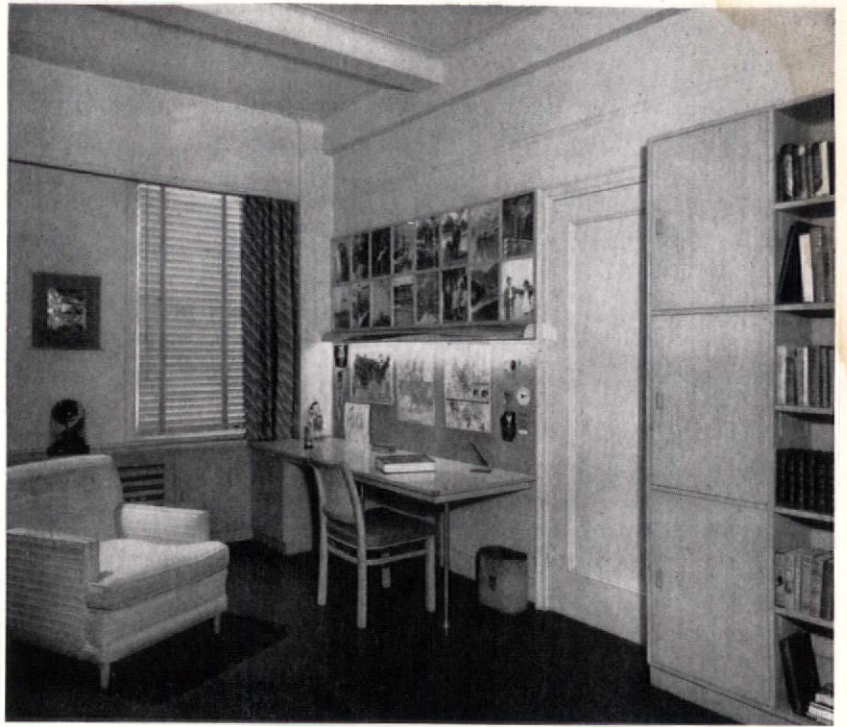

ROBERT M. DAMORA

JOSEPH DOUGLAS WEISS  
*Architect*



ELEVATION towards 1 1/4" scale

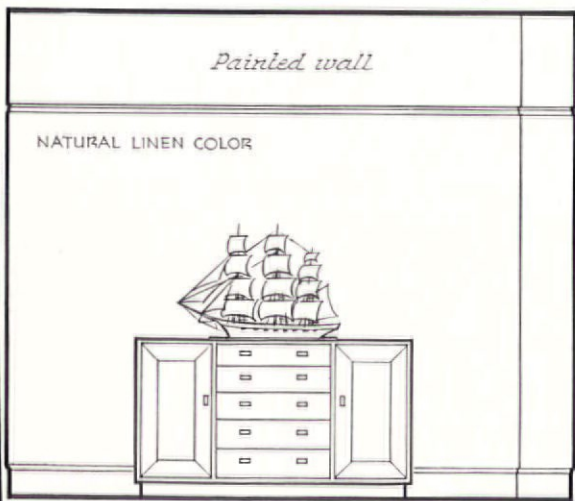

ELEVATION towards 3

PLAN  
1/4" scale

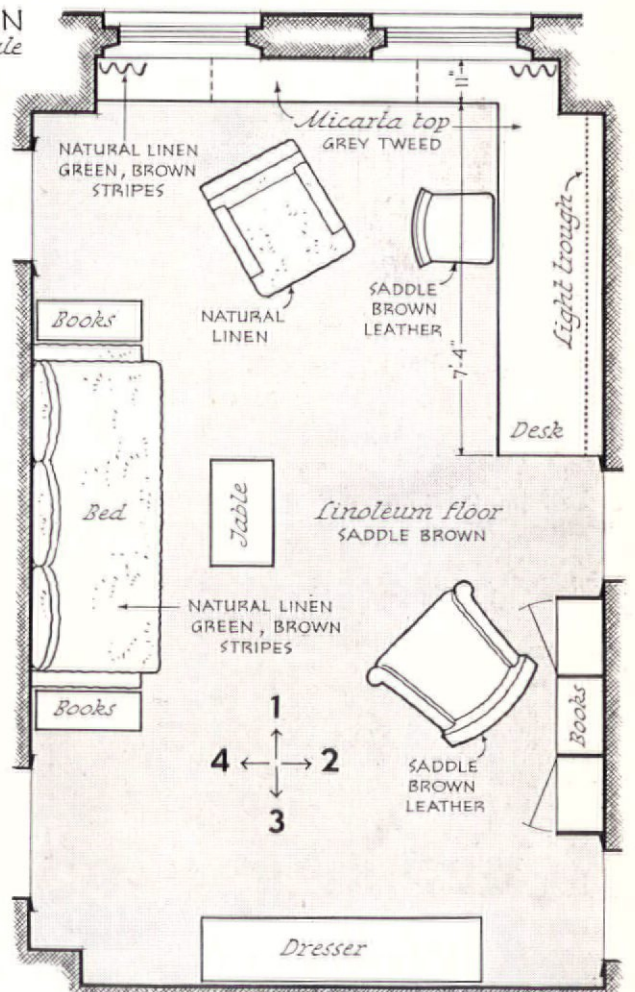

*Note.*  
ALL WOODWORK  
PICKLED QUARTERED  
OAK

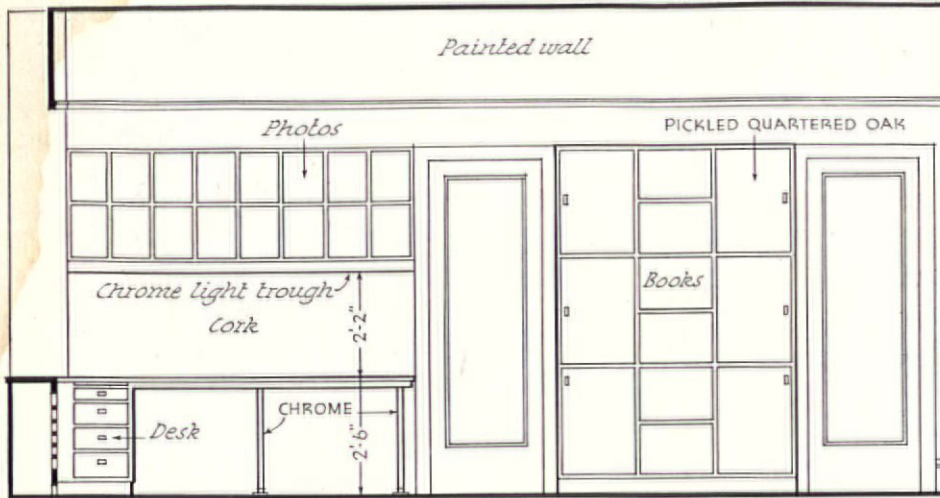

ELEVATION  
towards 2  
1/4" scale

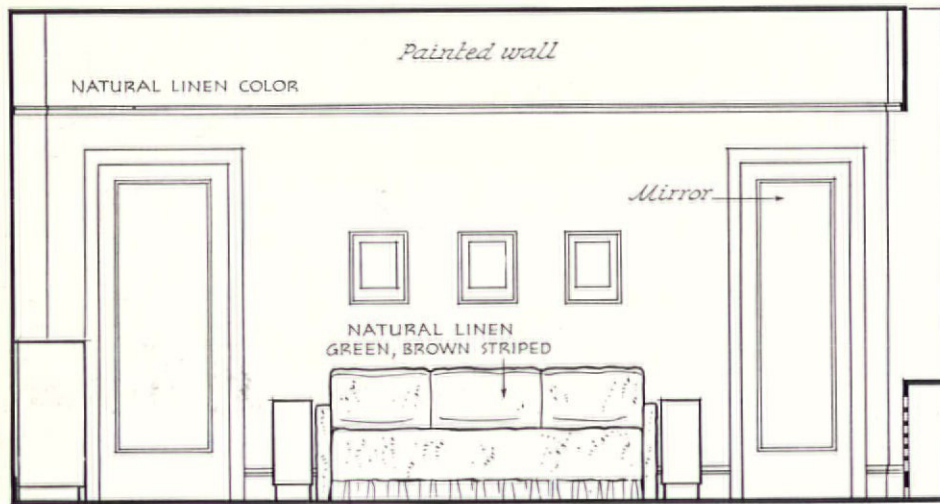

ELEVATION  
towards 4  
1/4" scale

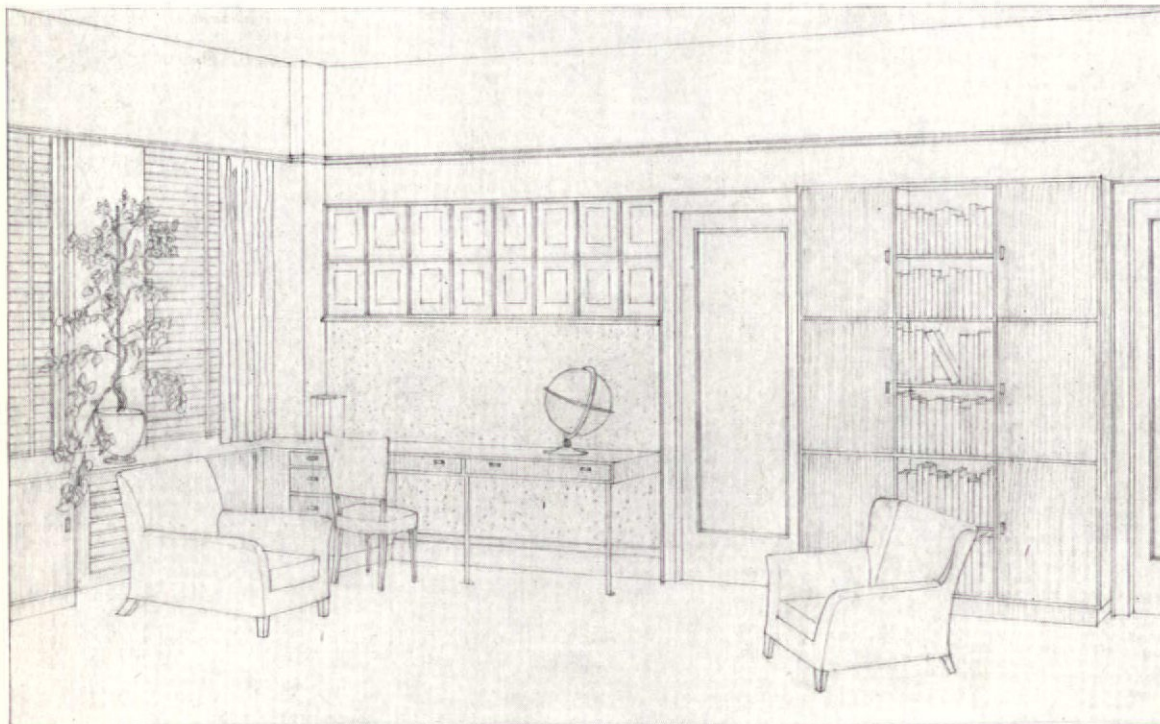

Architect's  
original  
drawing

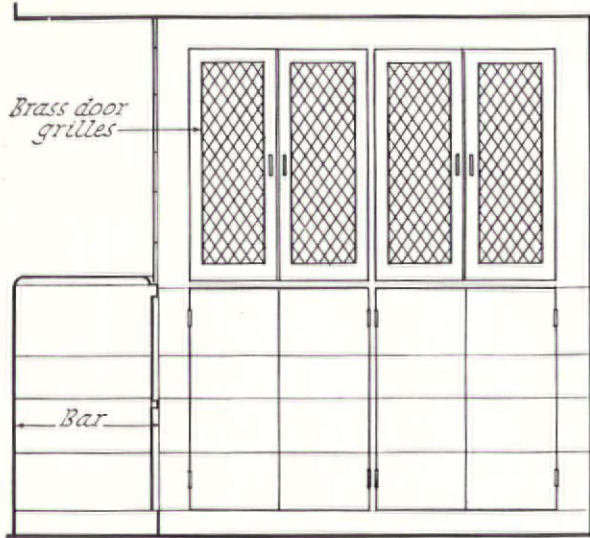

ELEVATION  $\frac{3}{8}$ " scale

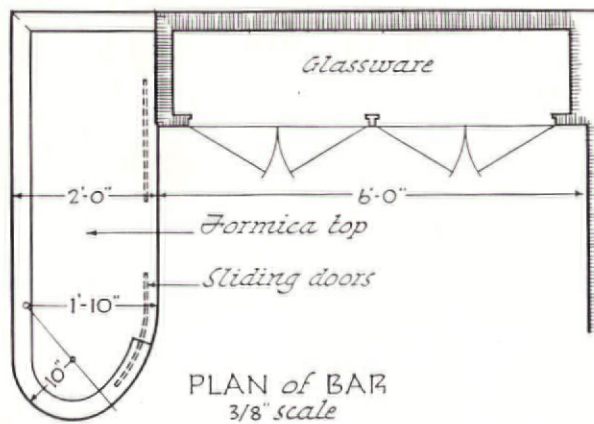

PLAN of BAR  $\frac{3}{8}$ " scale

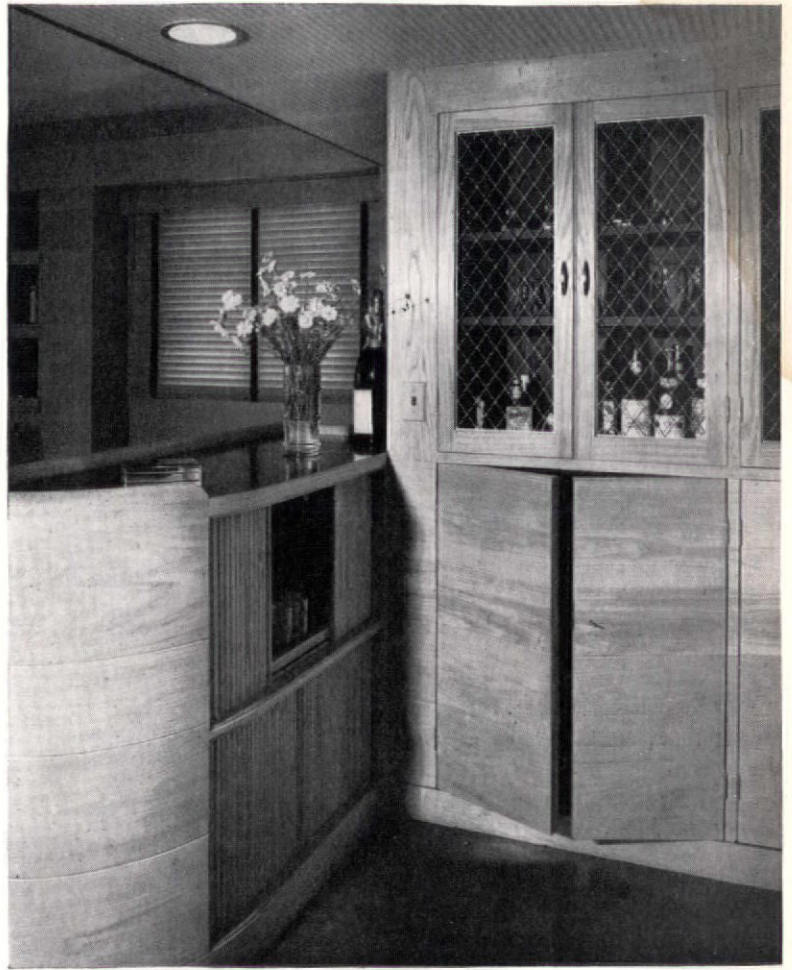

RODNEY M'CAY MORGAN

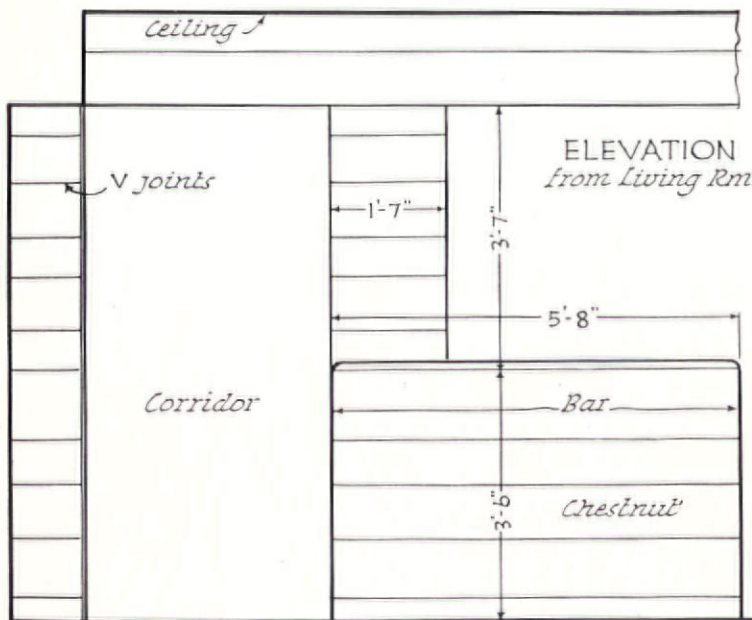

ELEVATION from Living Rm

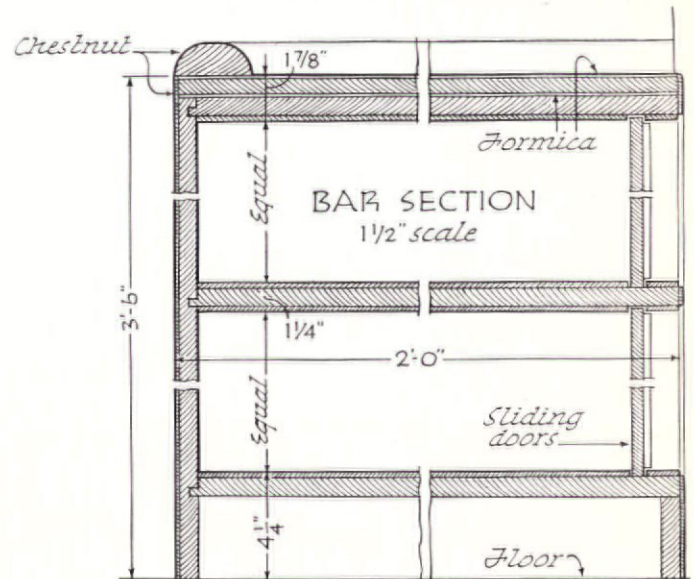

BAR SECTION  $\frac{1}{2}$ " scale

PLAN of DOOR Full size

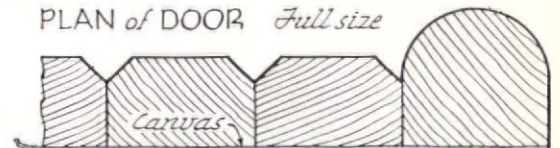

A. MUSGRAVE HYDE . . . Architect

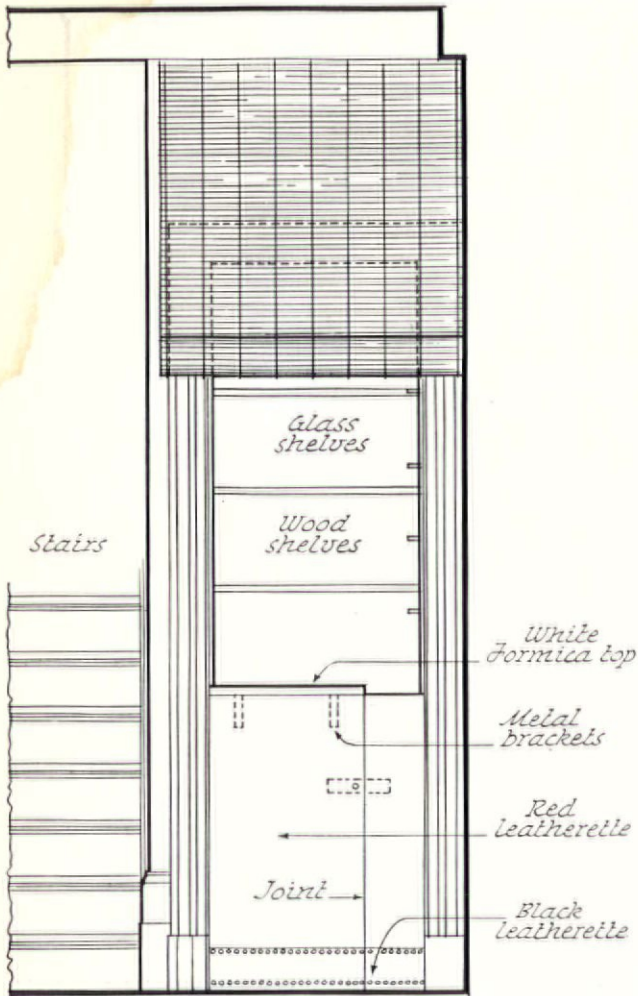

ELEVATION  $\frac{1}{2}$ " scale

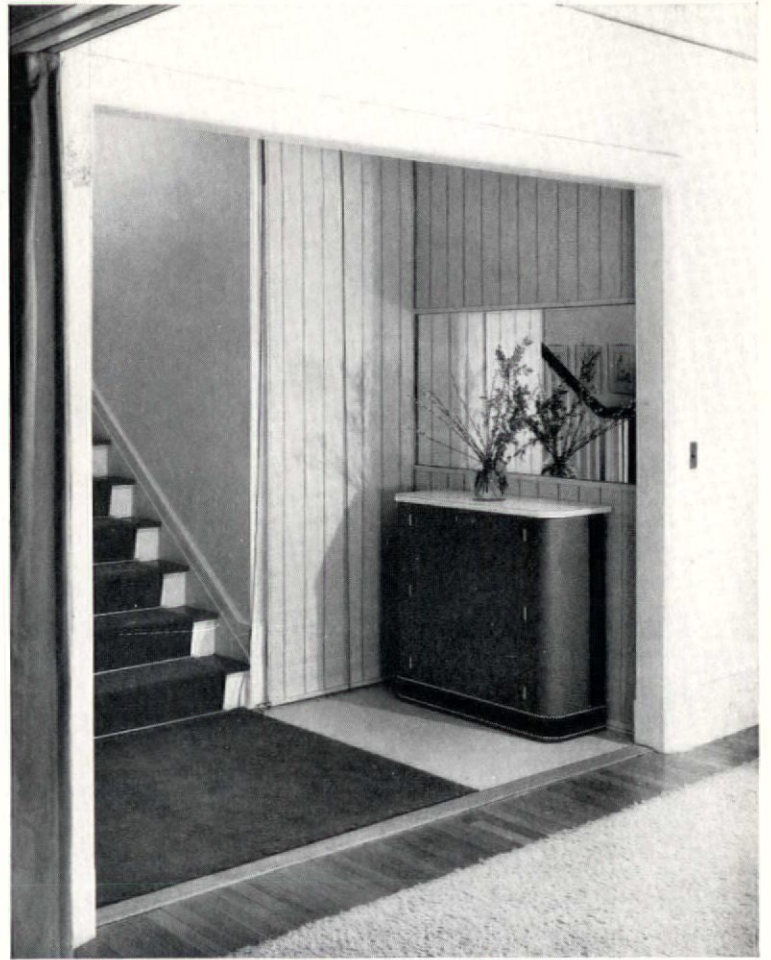

HERMANN BRAMMER

See next page for Bar in opened position

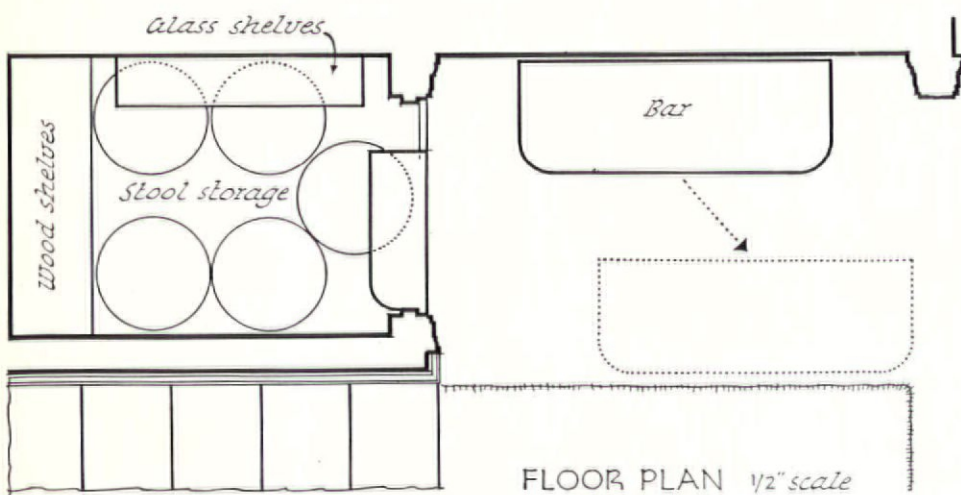

FLOOR PLAN  $\frac{1}{2}$ " scale

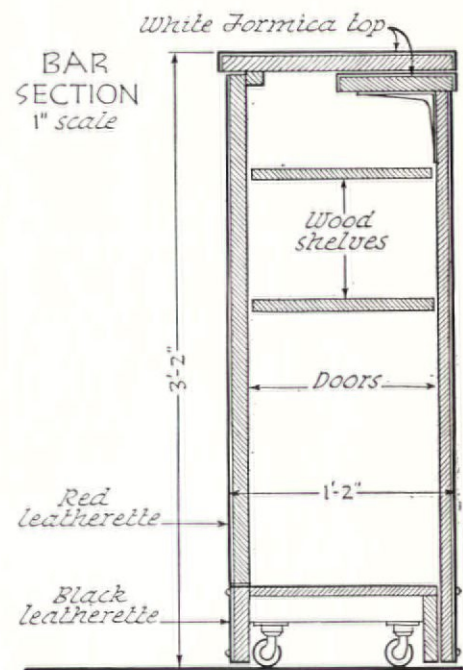

FELIX AUGENFELD . . . . . Designer



HERMANN BRAMMER

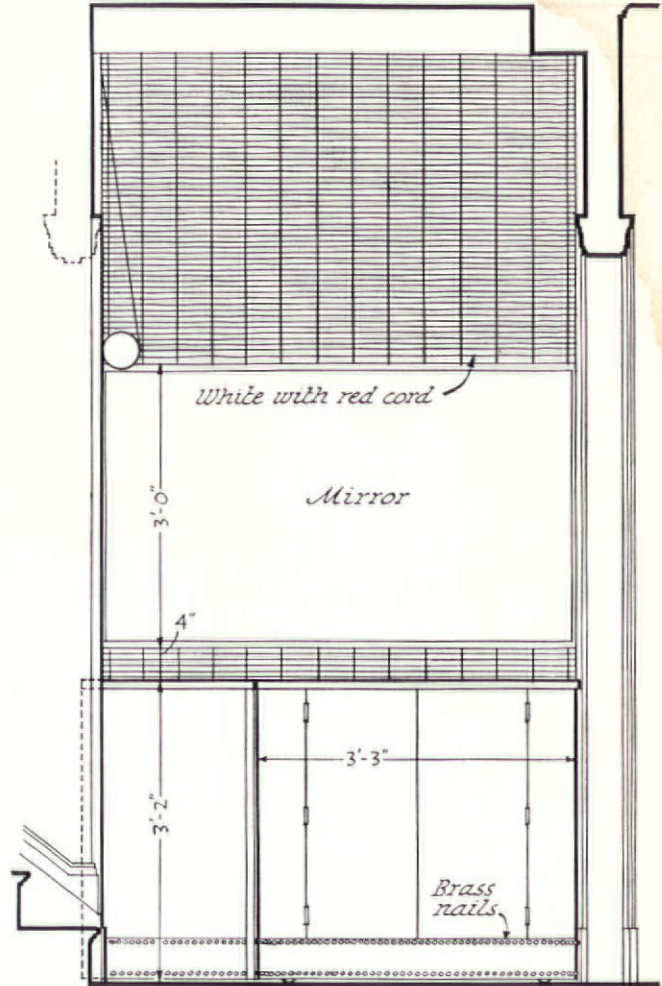

FRONT ELEVATION 1/2" scale

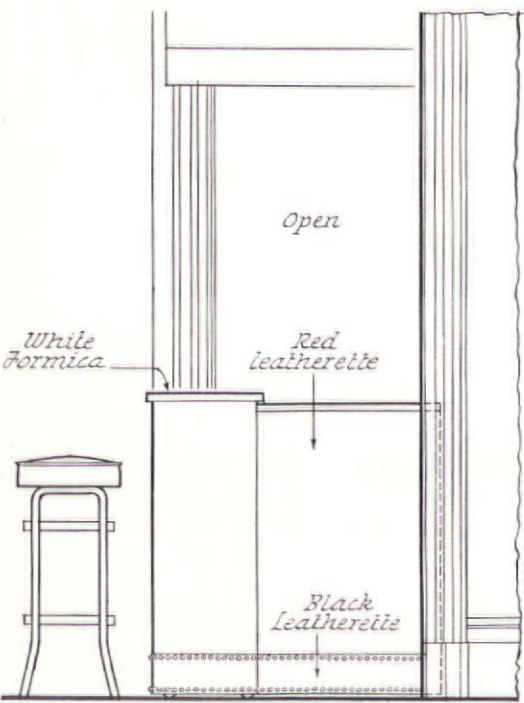

SIDE ELEVATION 1/2" scale

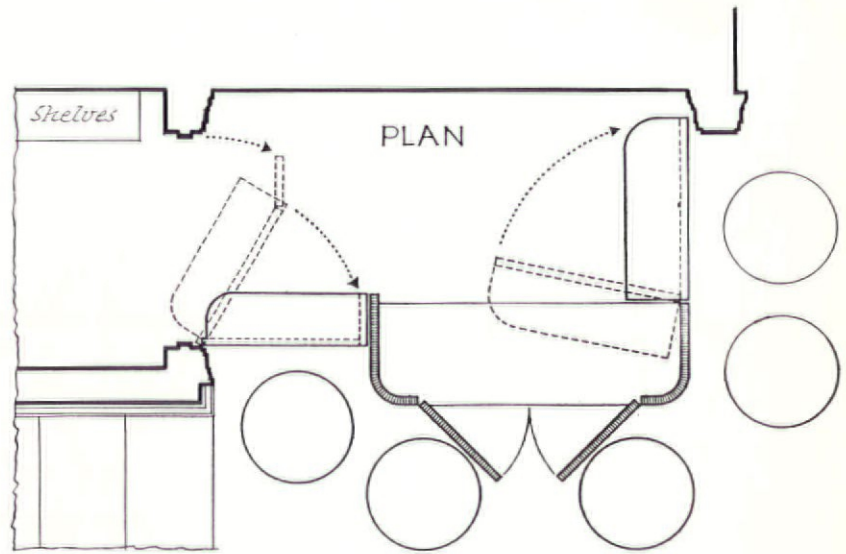

FELIX AUGENFELD . . . . . Designer

SELECTED ARCHITECTURAL DETAILS—BUILT-IN RADIO

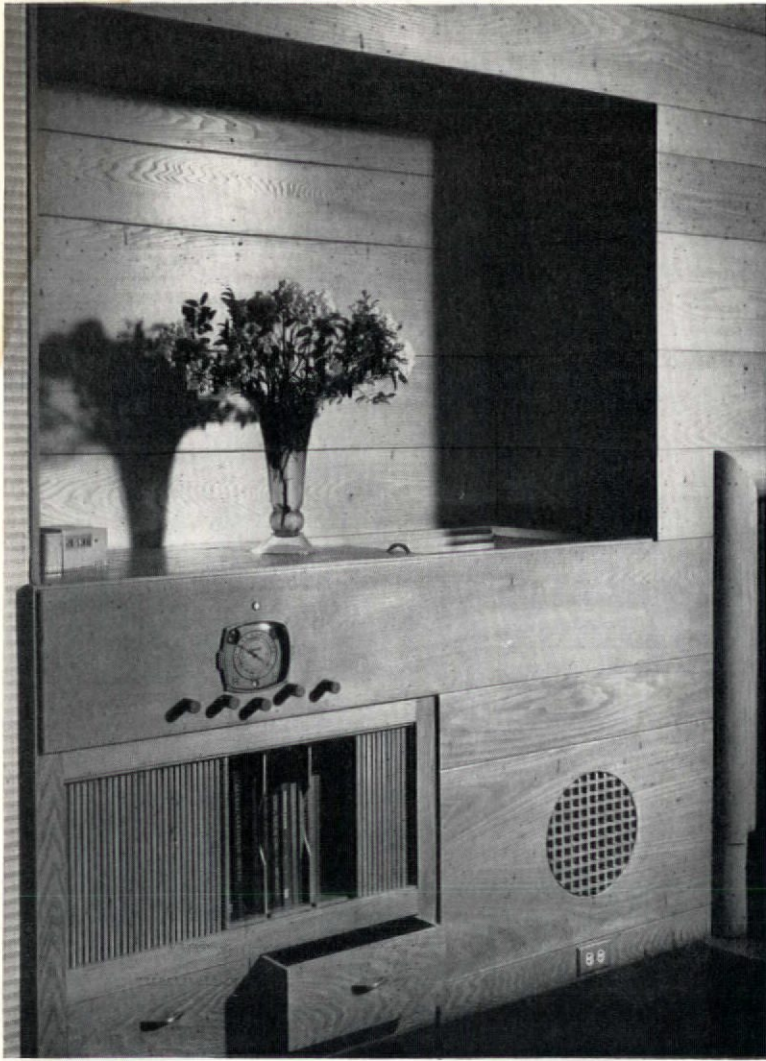

RODNEY McCAY MORGAN

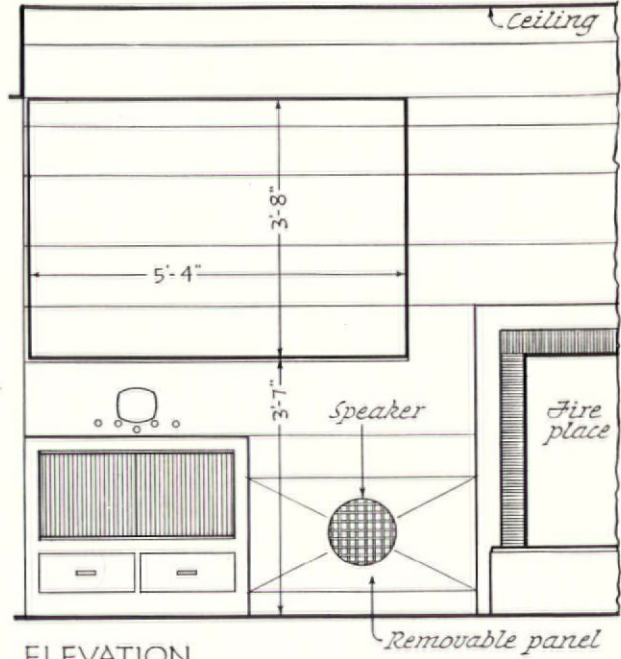

ELEVATION  
3/8" scale



PLAN

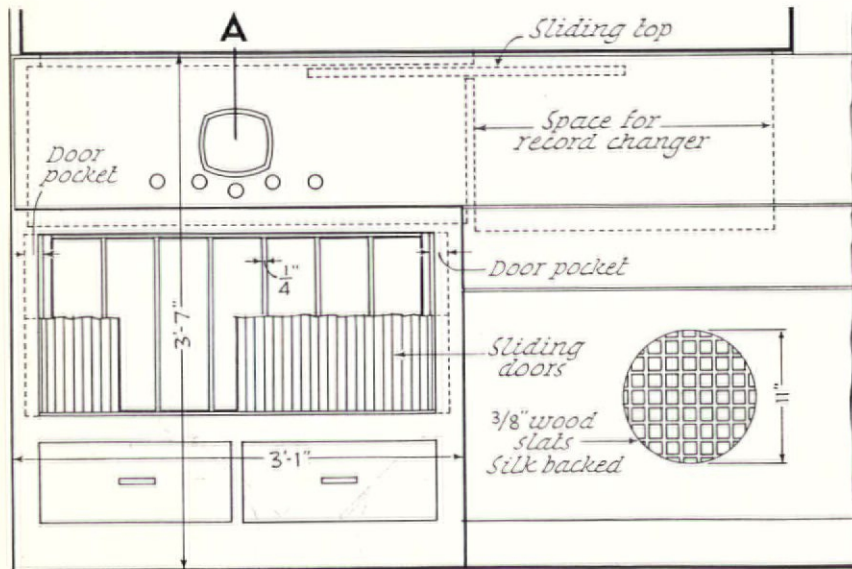

ELEVATION  
3/4" scale

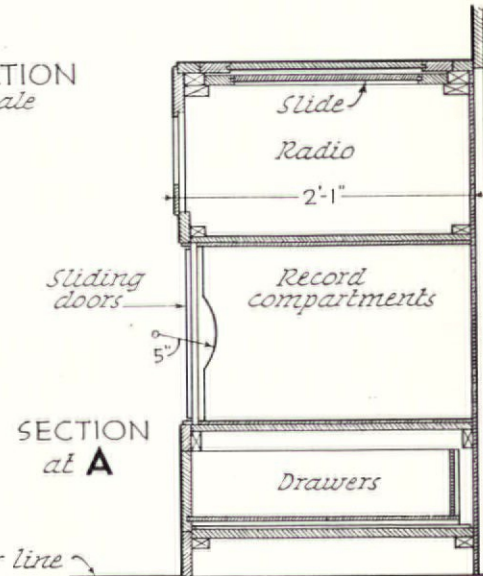

A. MUSGRAVE HYDE . . . Architect

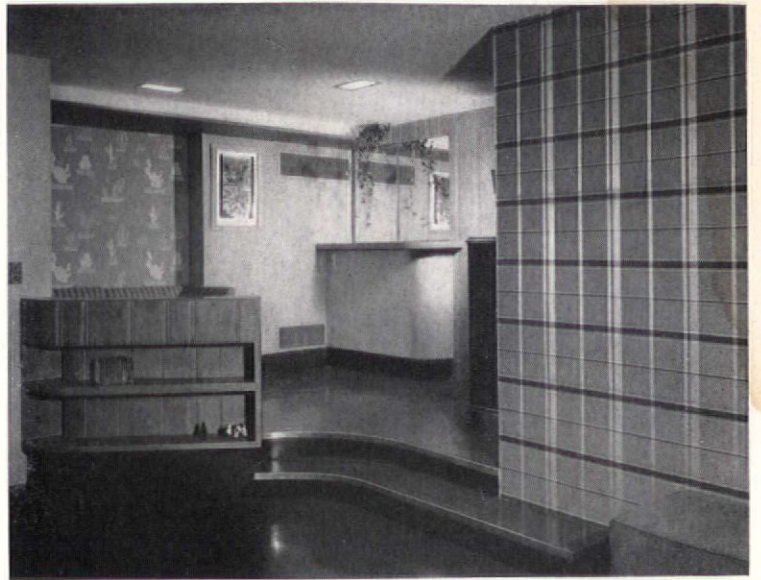

Photos by THURMAN ROTAN

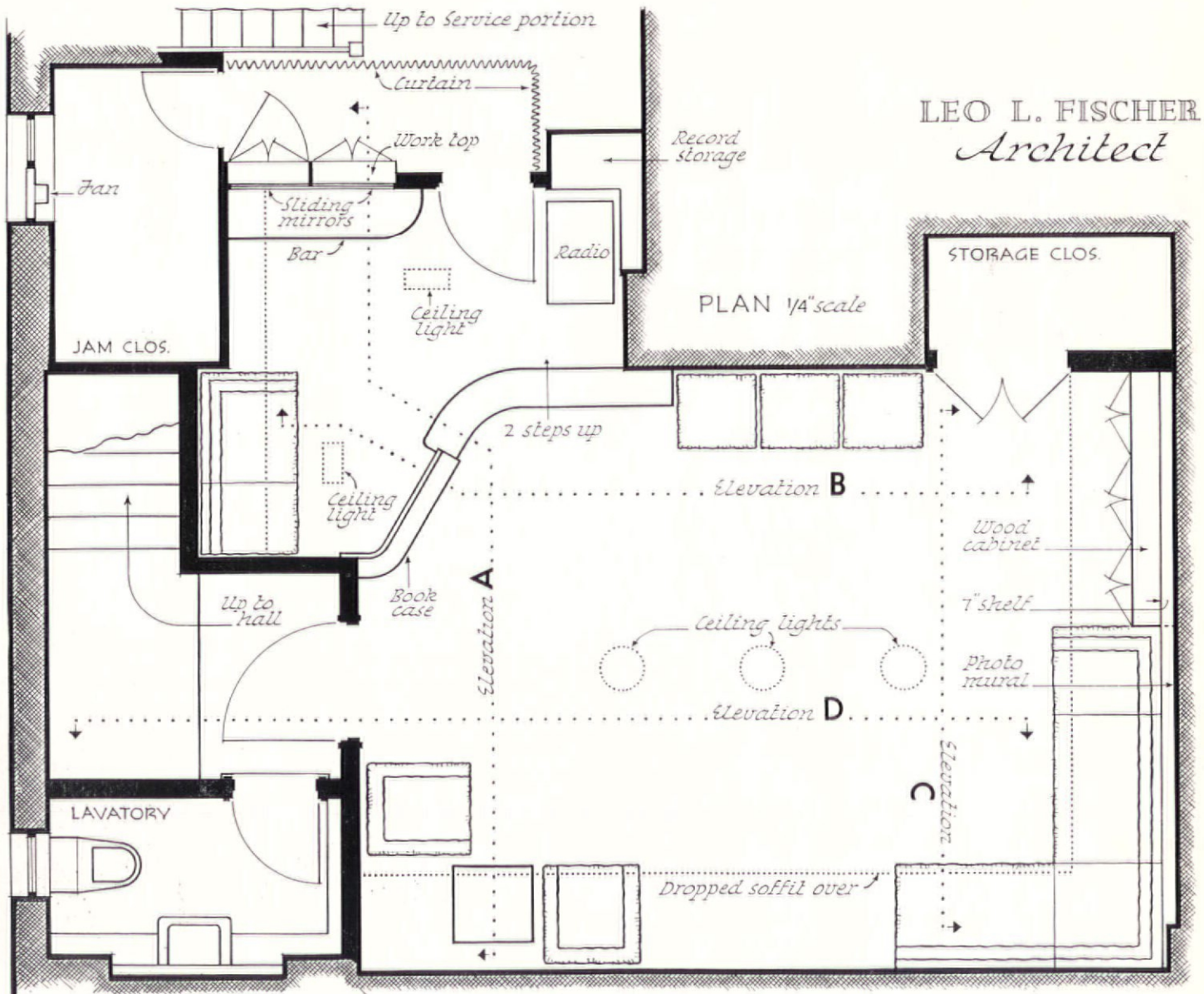

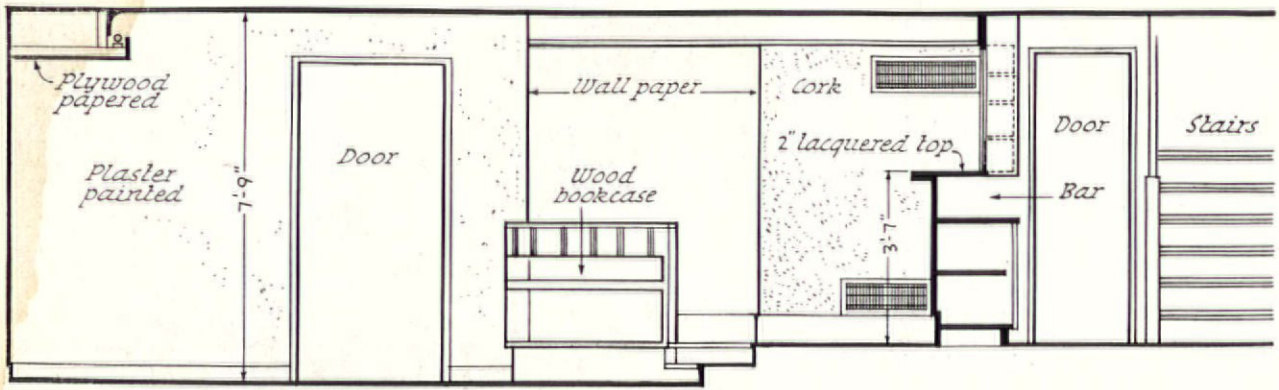

ELEVATION at A

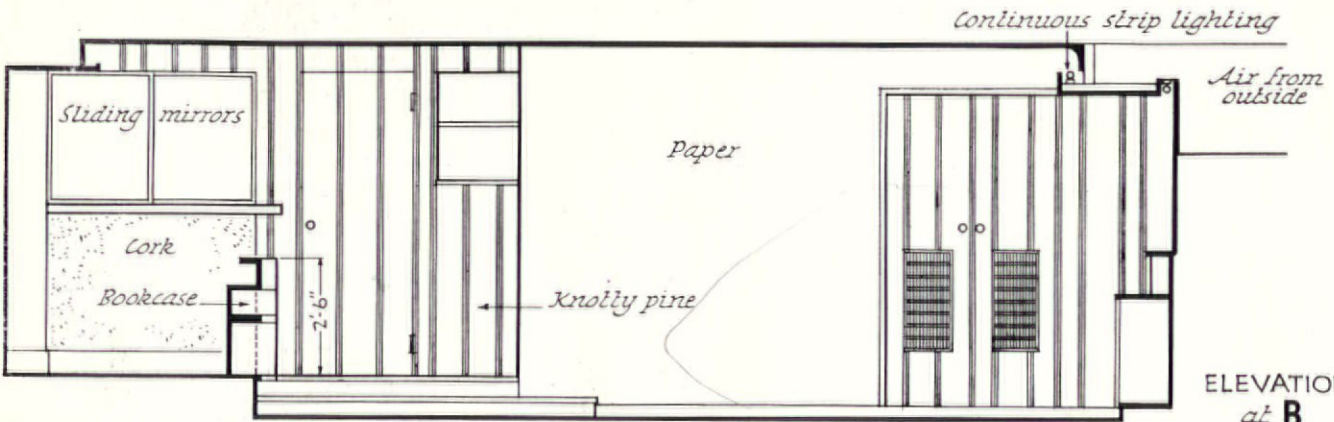

ELEVATION at B

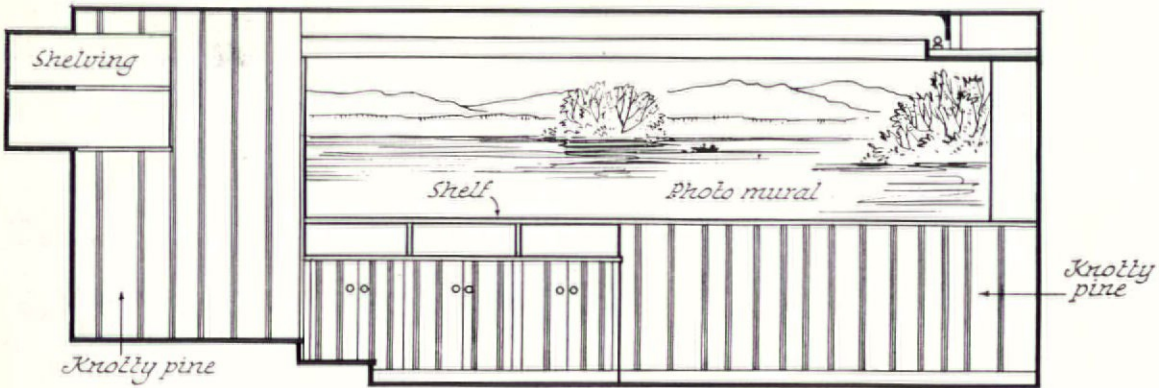

ELEVATION at C

All Elevations at 1/4" scale

LEO L. FISCHER . . . . . Architect

ELEVATION at D

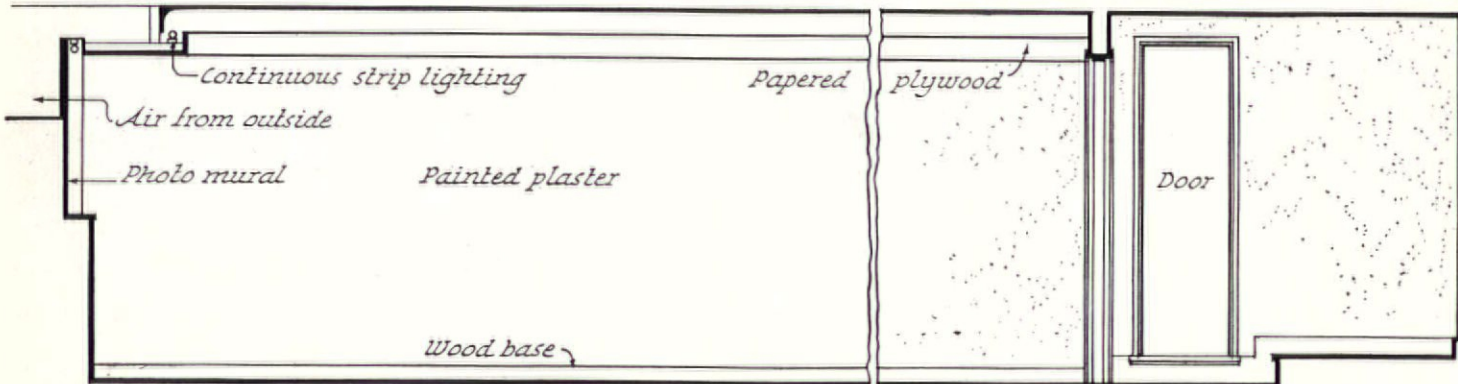



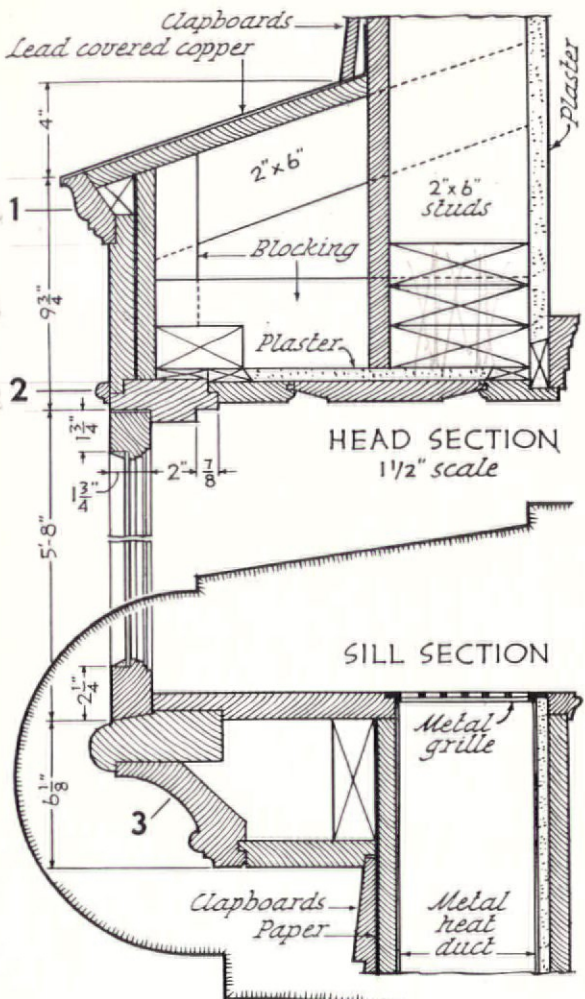

GEORGE H. VAN ANDA

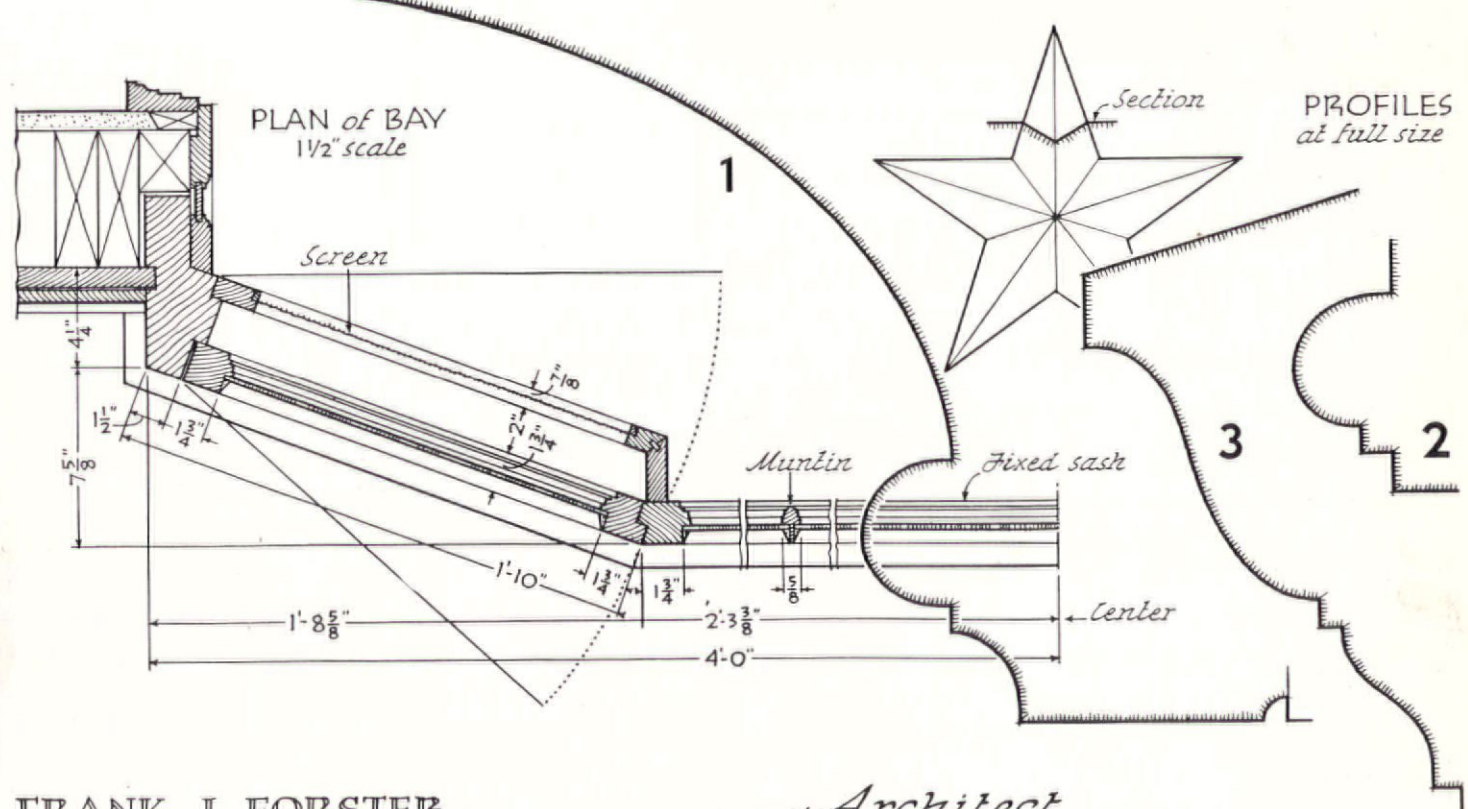

FRANK J. FORSTER . . . . . Architect



GEORGE H. VAN ANDA

SECTION *Through BAY*  
3/4" scale

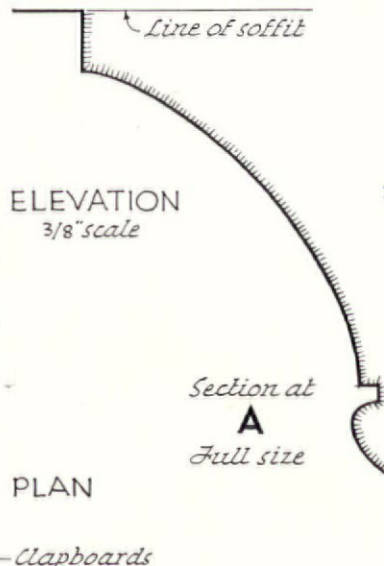
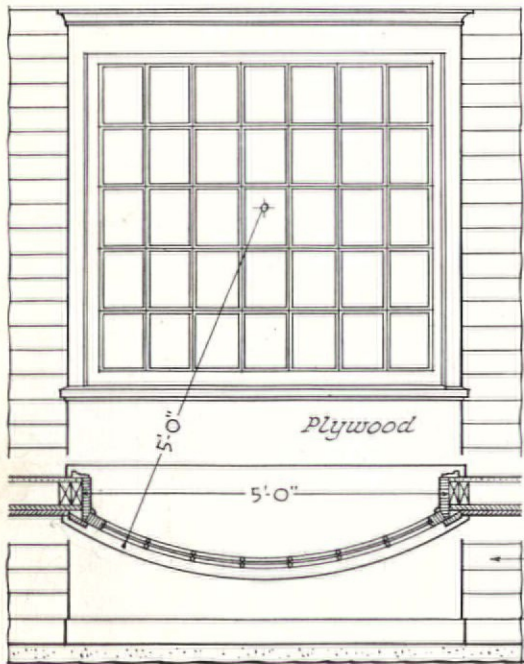
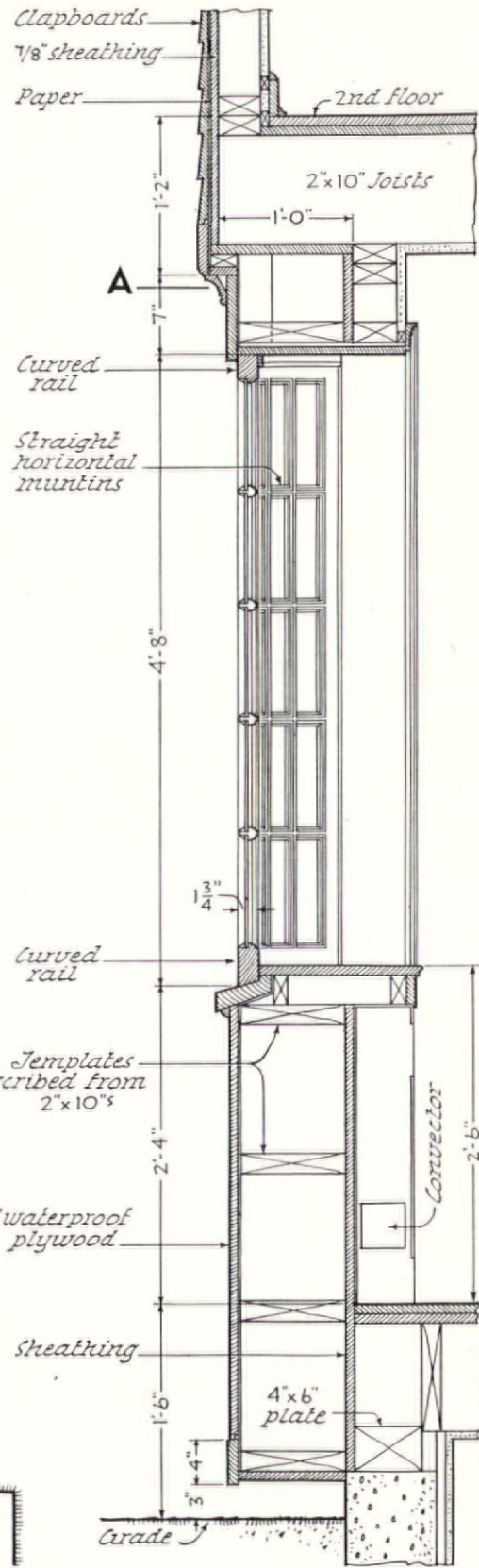

WILLIS N. MILLS . . . . *Architect*

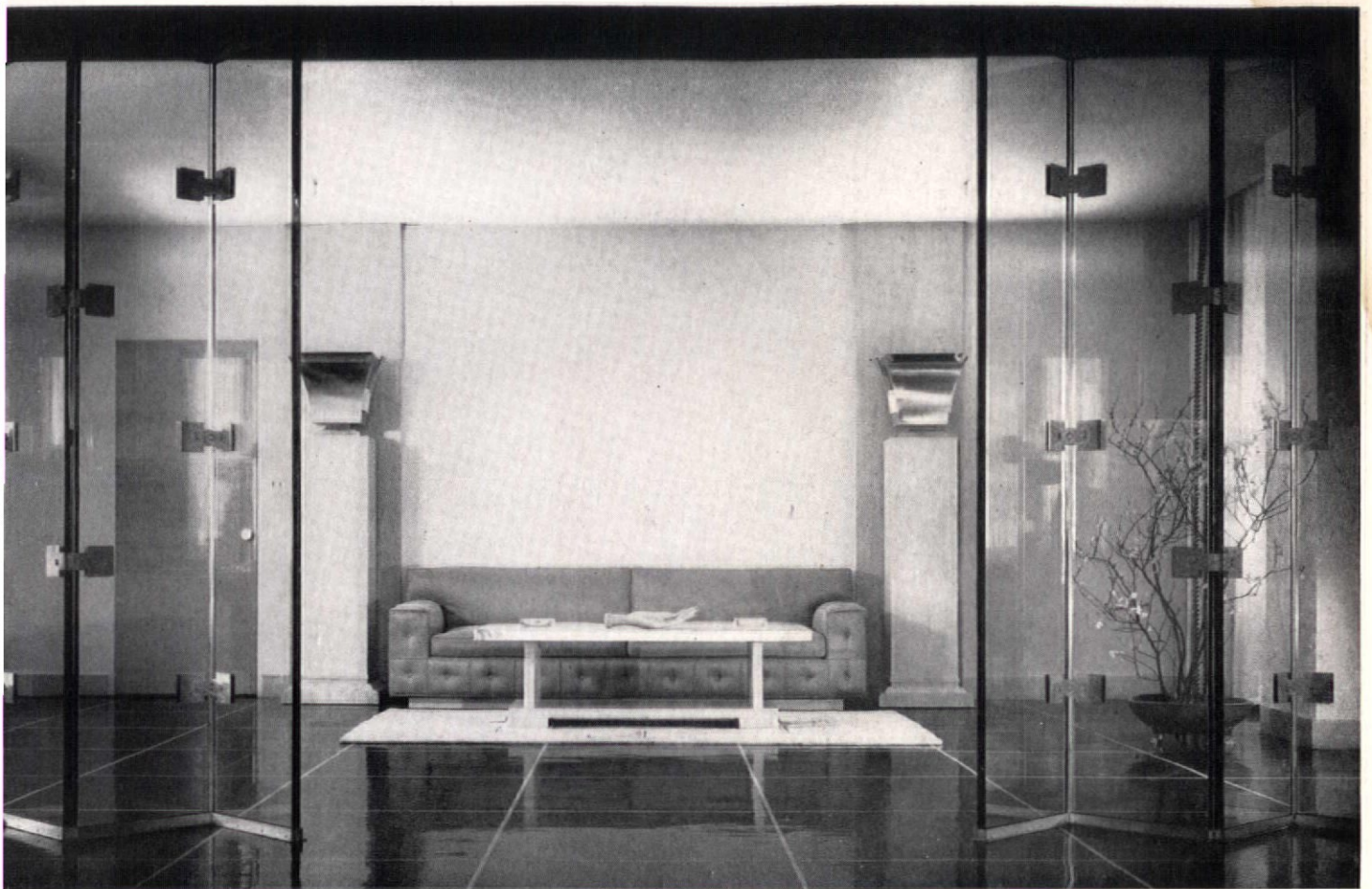

RICHARD GARRISON

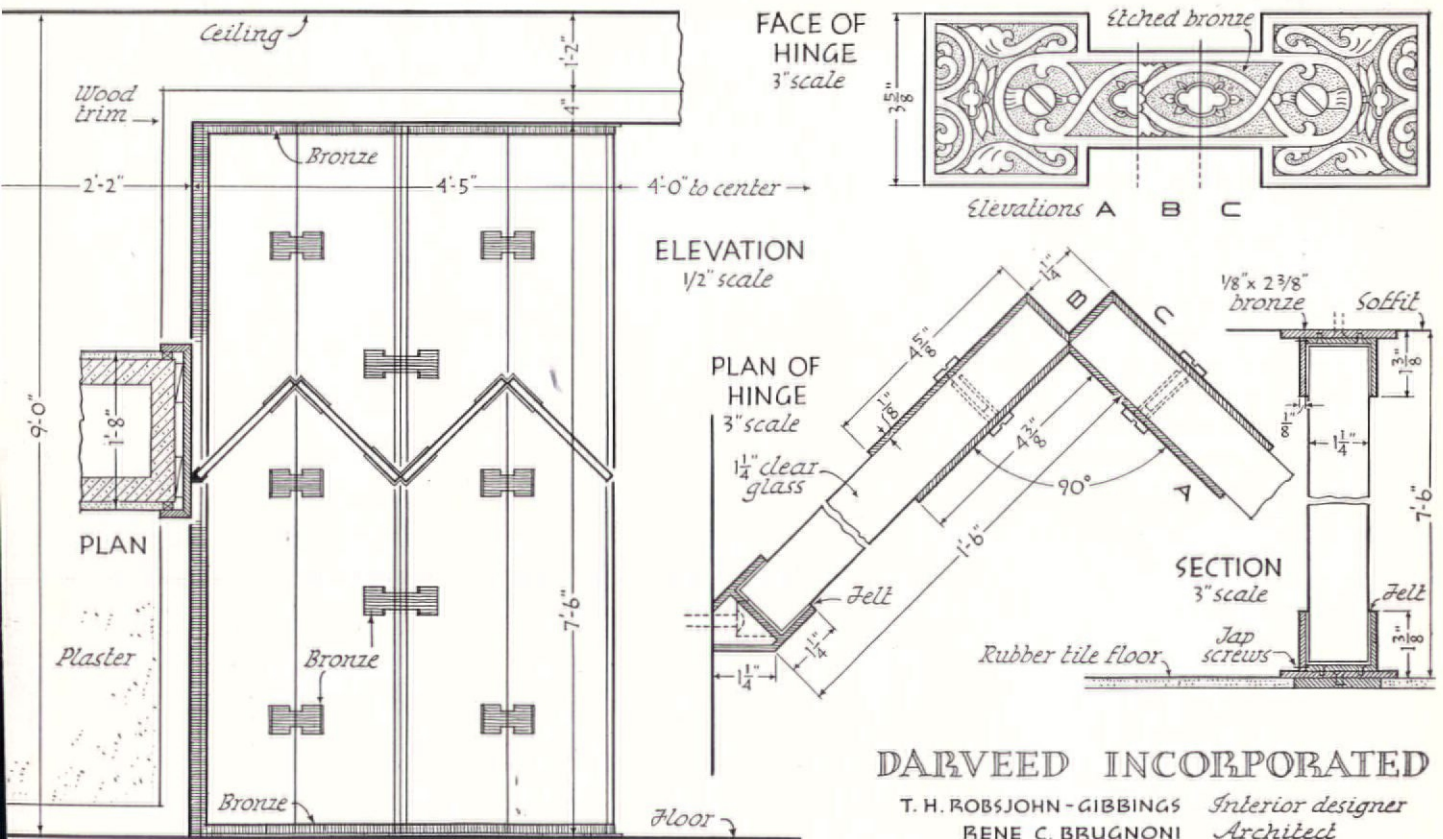

DARVEED INCORPORATED

T. H. ROBSJOHN - GIBBINGS *Interior designer*  
RENE C. BRUGNONI *Architect*

ROSS STEWART . . . . . *Manager*

INTERIOR DECORATING DEPARTMENT, W. & J. SLOAN



LOUIS WERNER

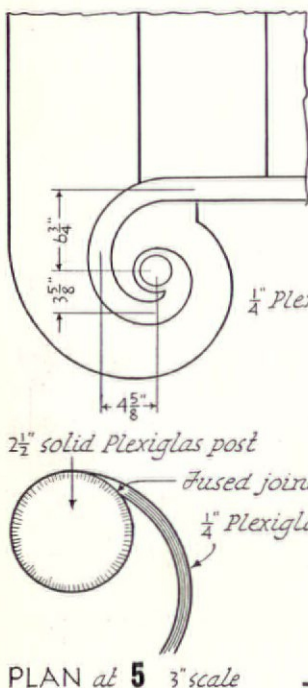
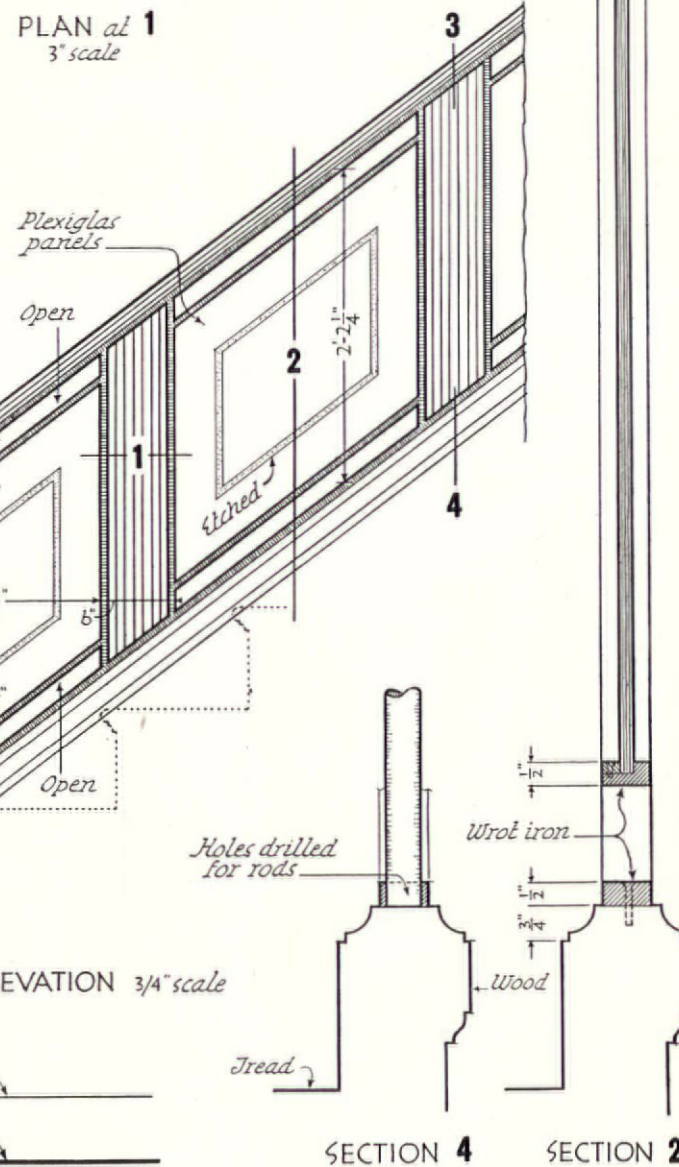
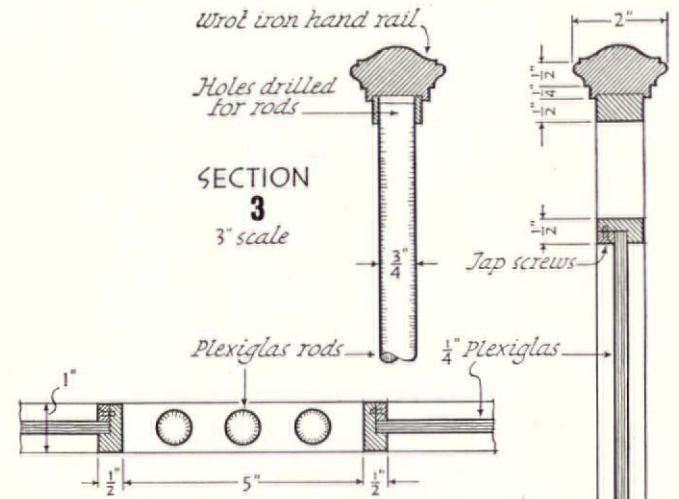

PLAN AT NEWEL  
3/4" scale

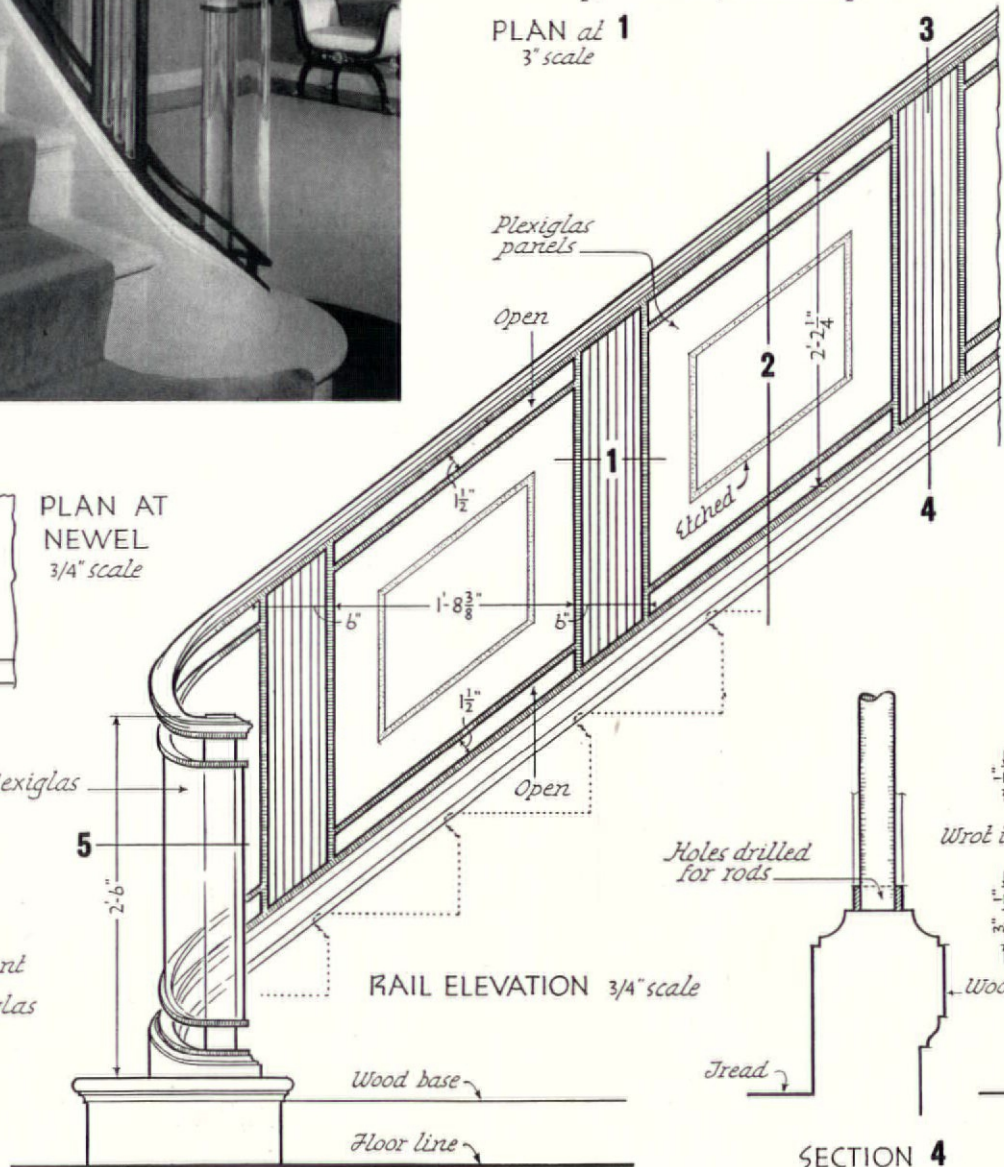

RAIL ELEVATION 3/4" scale

SECTION 4 SECTION 2



Photos by WILLIAM G. BLAND

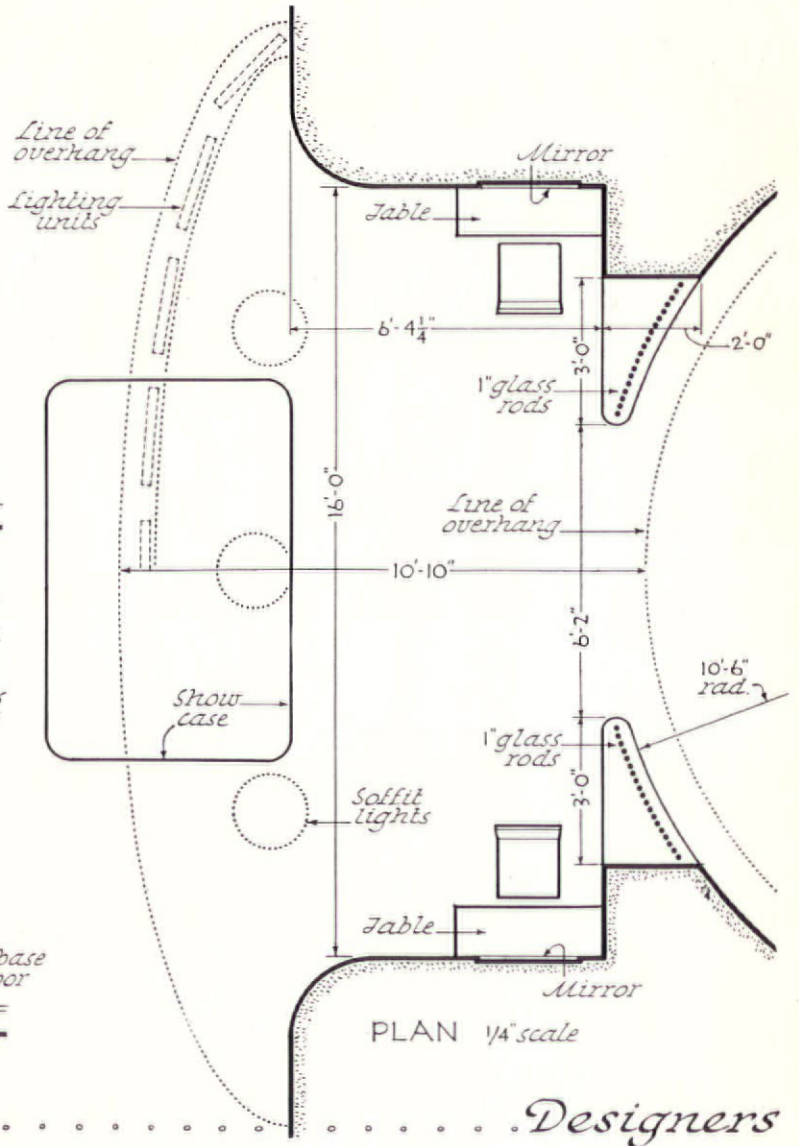
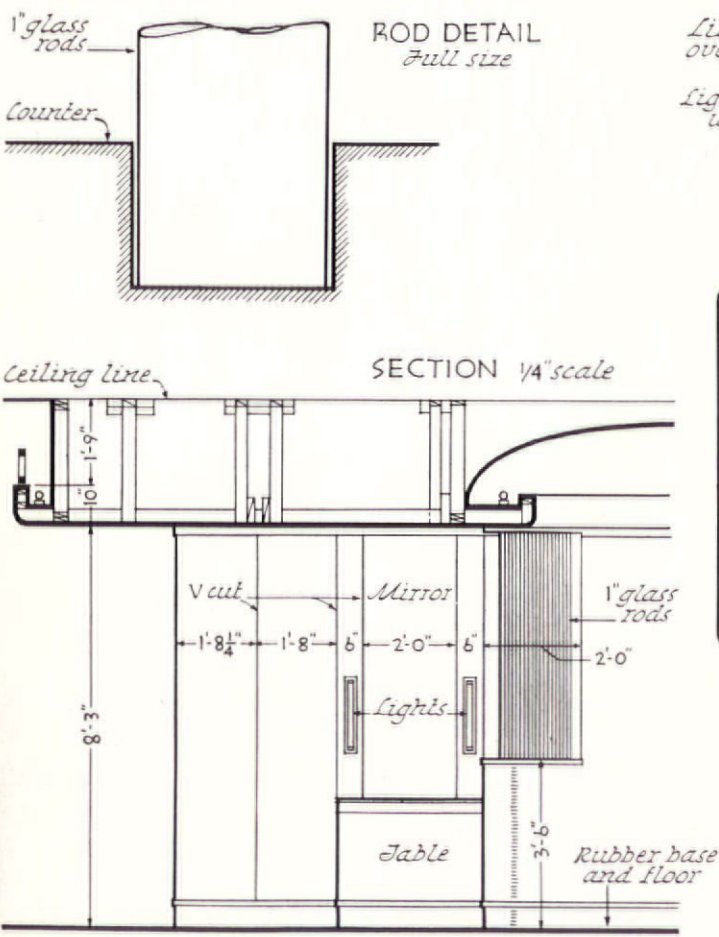

EMIL J. PAIDAR, INC. . . . . Designers

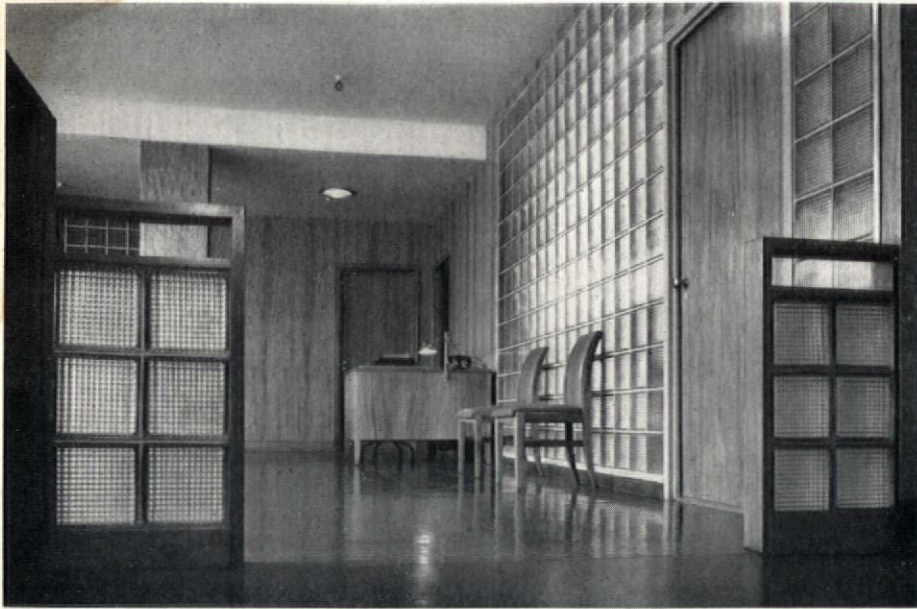

Photos by F. S. LINCOLN

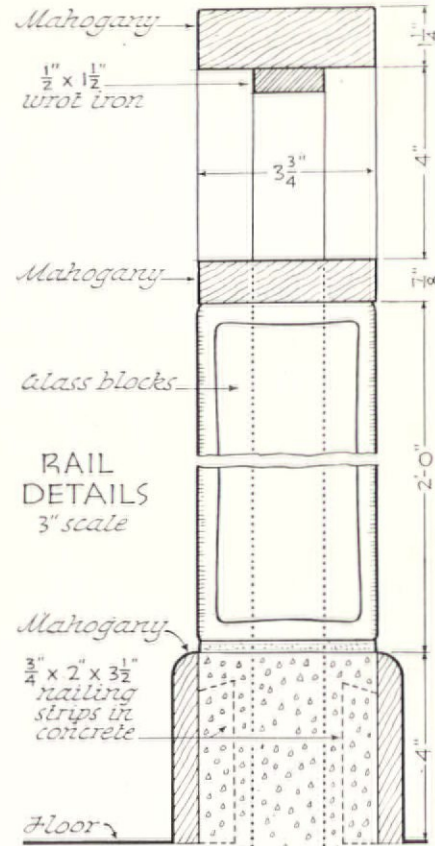

SECTION 1

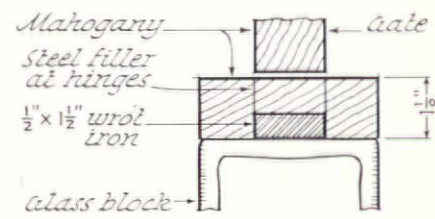

SECTION 2

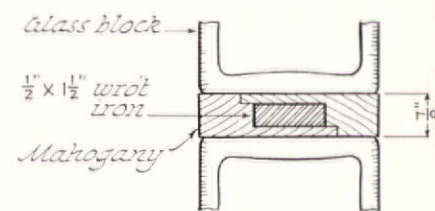

SECTION 3

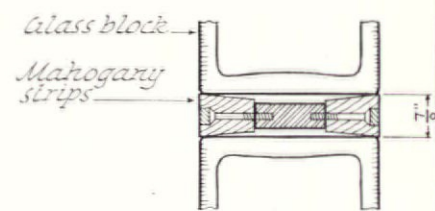

SECTION 4

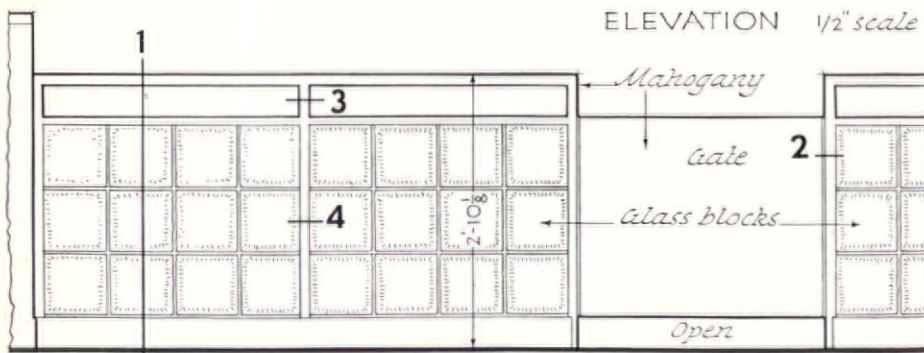

JOSEPH DOUGLAS WEISS . . . . . Architect

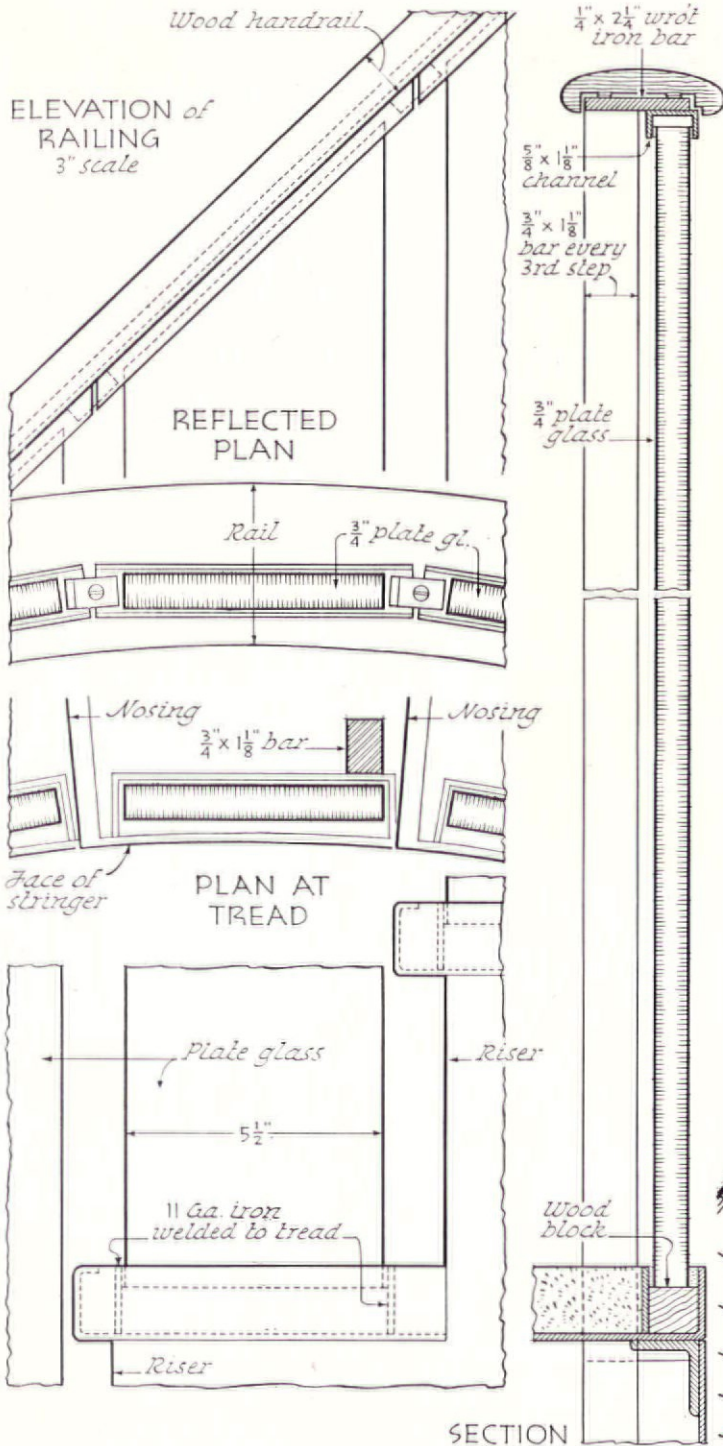

ROBERT M. DAMORA

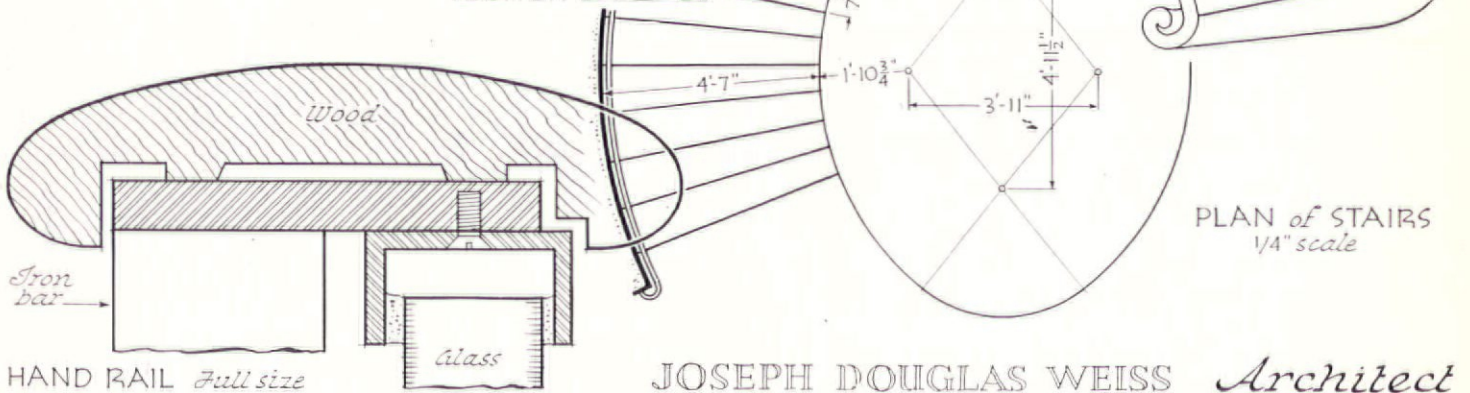

JOSEPH DOUGLAS WEISS Architect



ROBERT M. DAMORA

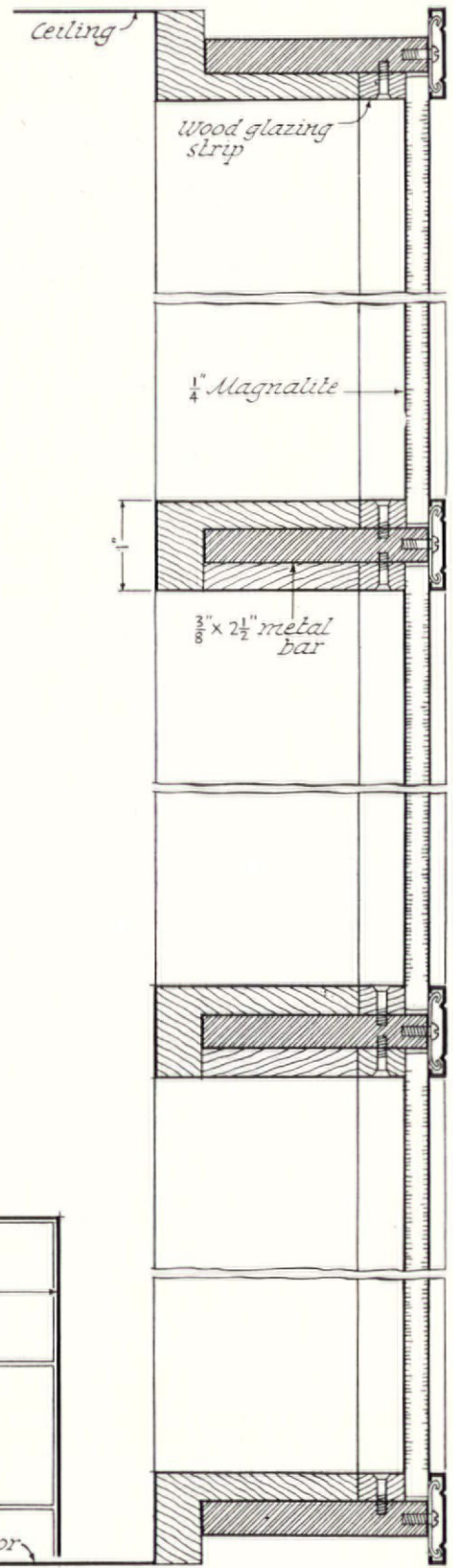

WINDOW SECTION  
Half full size

ELEVATION 1/4" scale

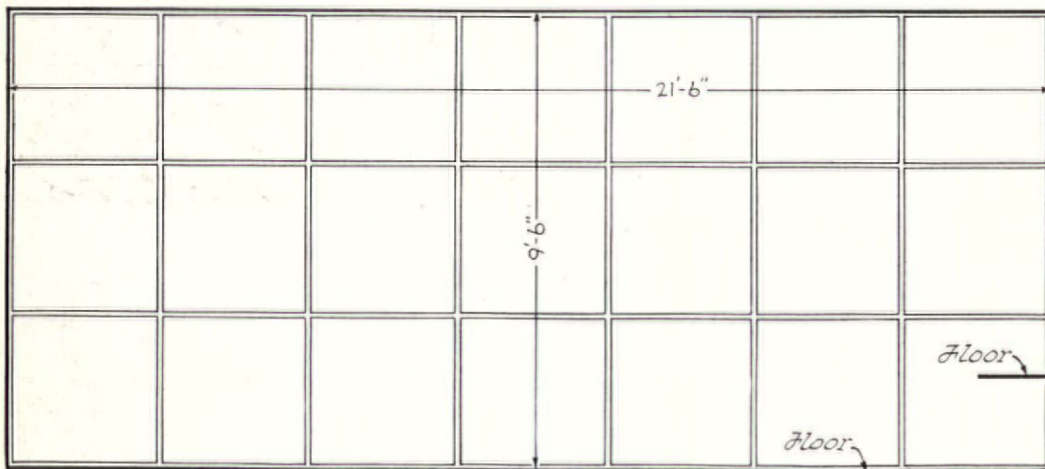

JOSEPH DOUGLAS WEISS . . . . . Architect



SELECTED ARCHITECTURAL DETAILS—USES OF GLASS

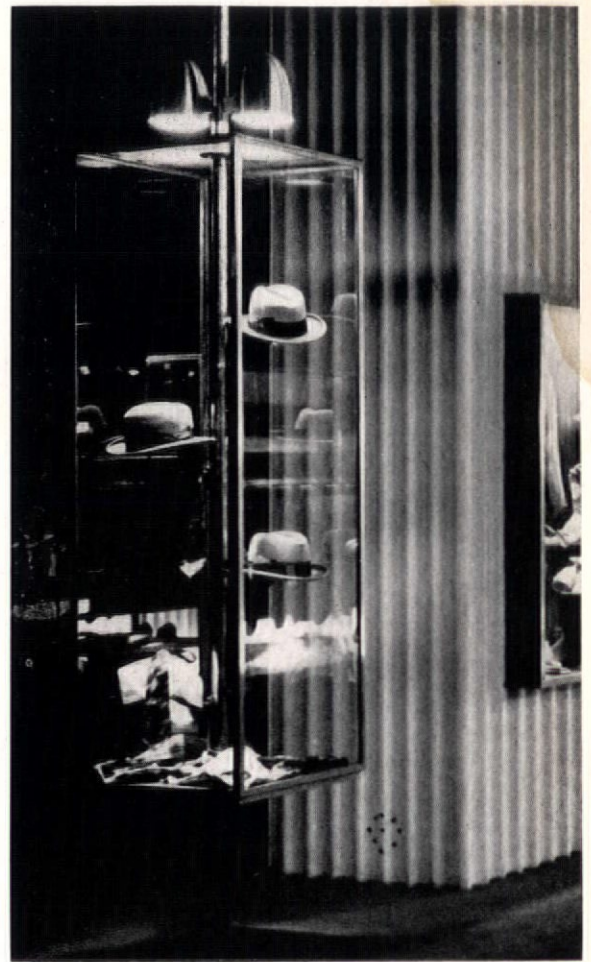
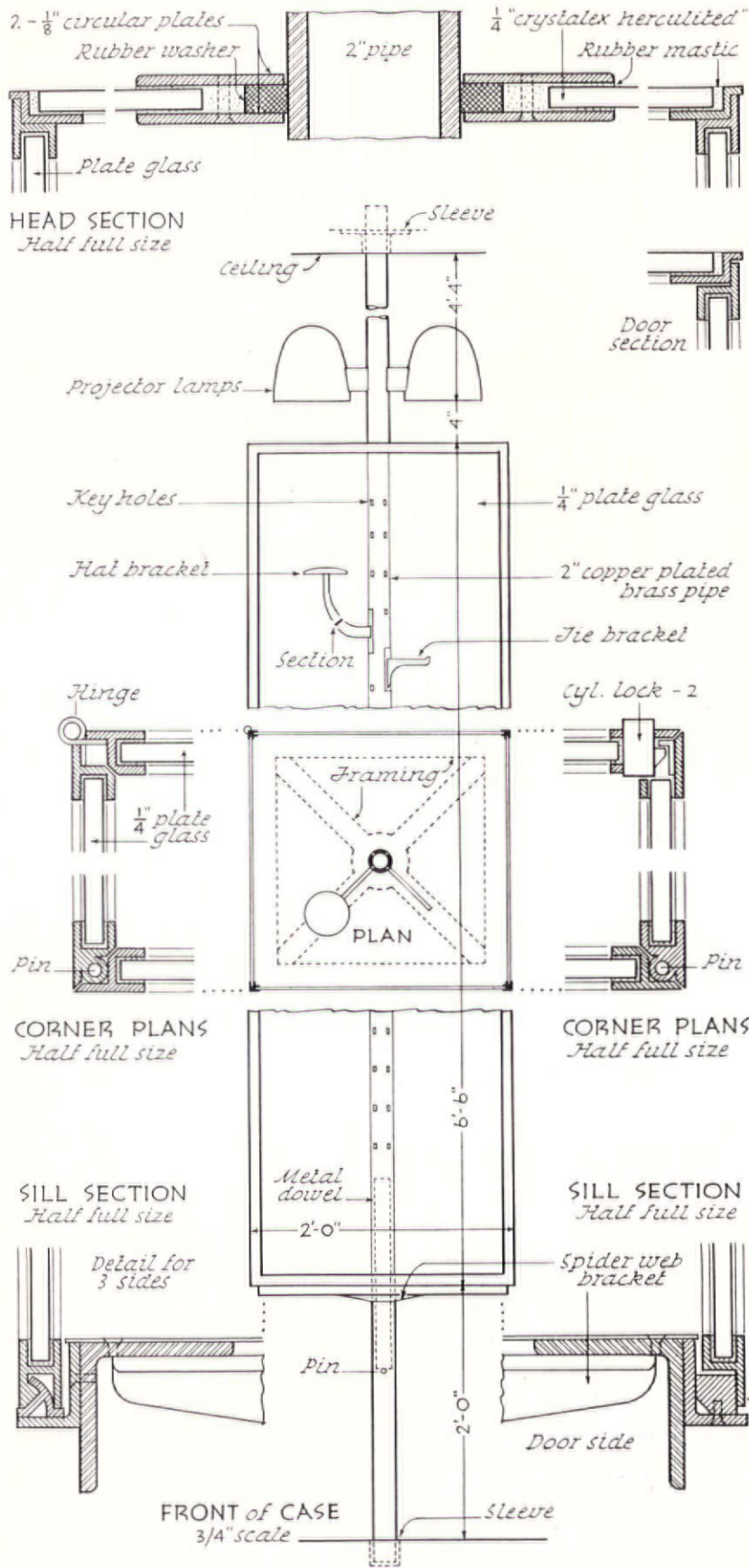

EZRA STOLLER

GLASS SCREEN DETAILS

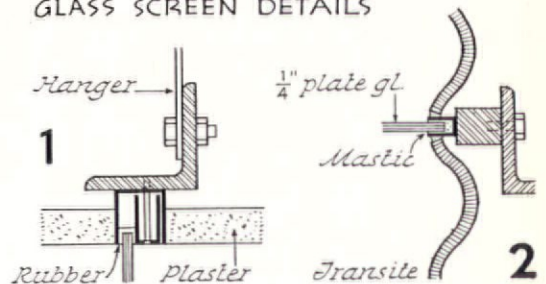

MORRIS KETCHUM, Jr. . . . . Architect  
VICTOR GRUENBAUM . . . . . ASSOCIATE

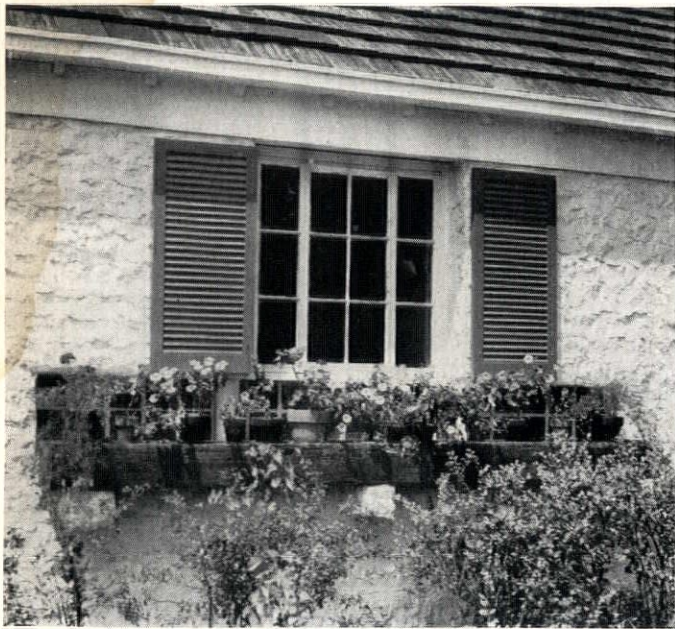

SECTION  
1/2" scale

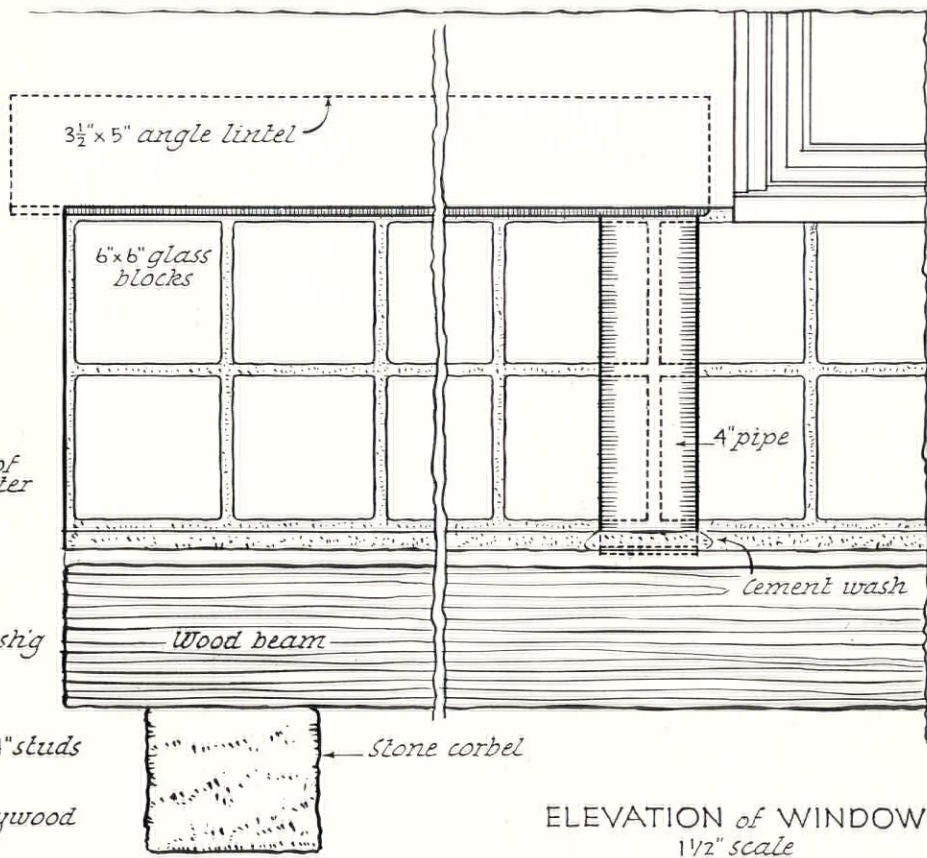
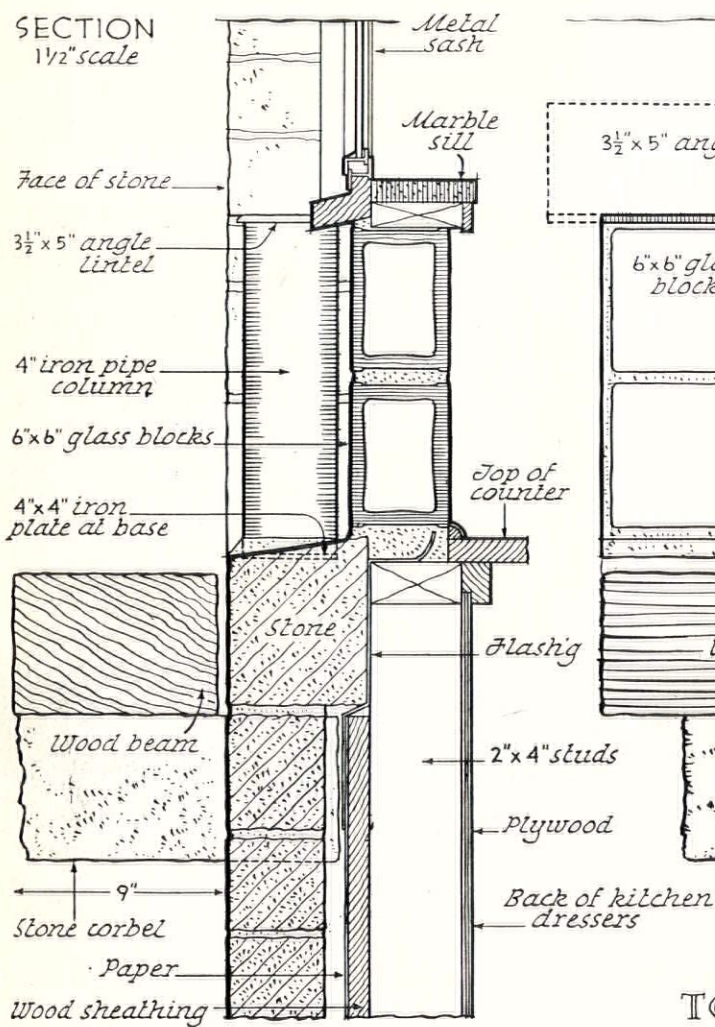

ELEVATION of WINDOW  
1/2" scale

TODD TIBBALS . . . . . Architect



Photos by F. S. LINCOLN

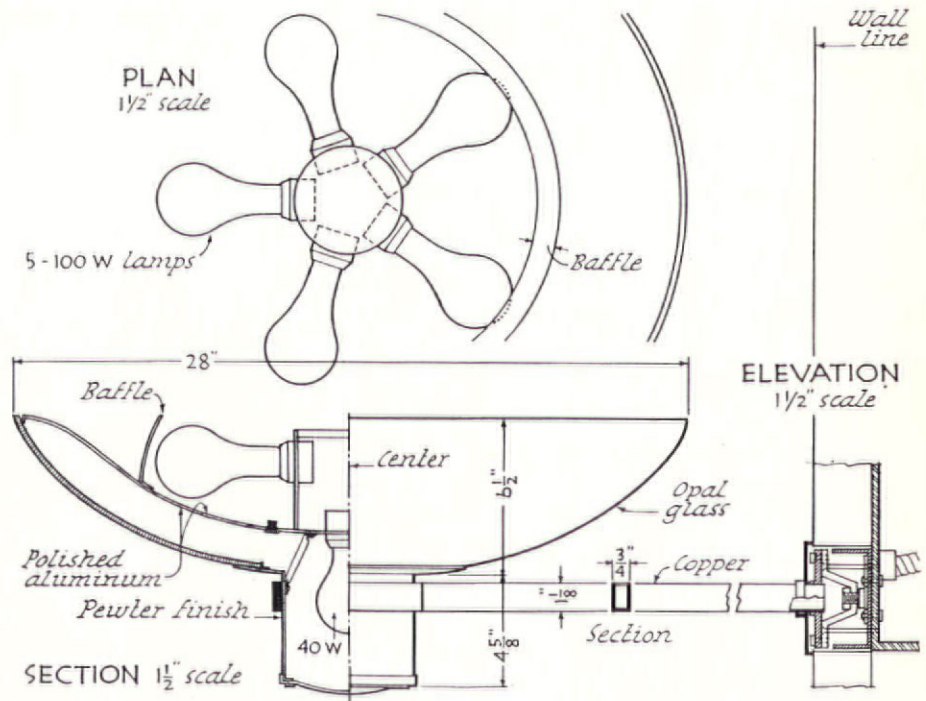
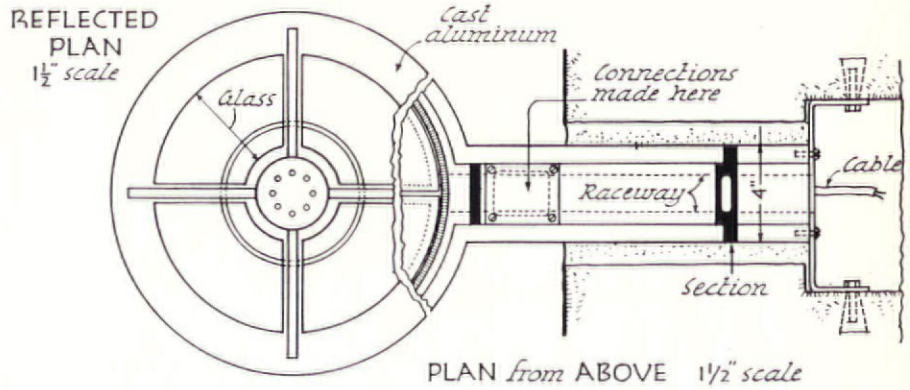
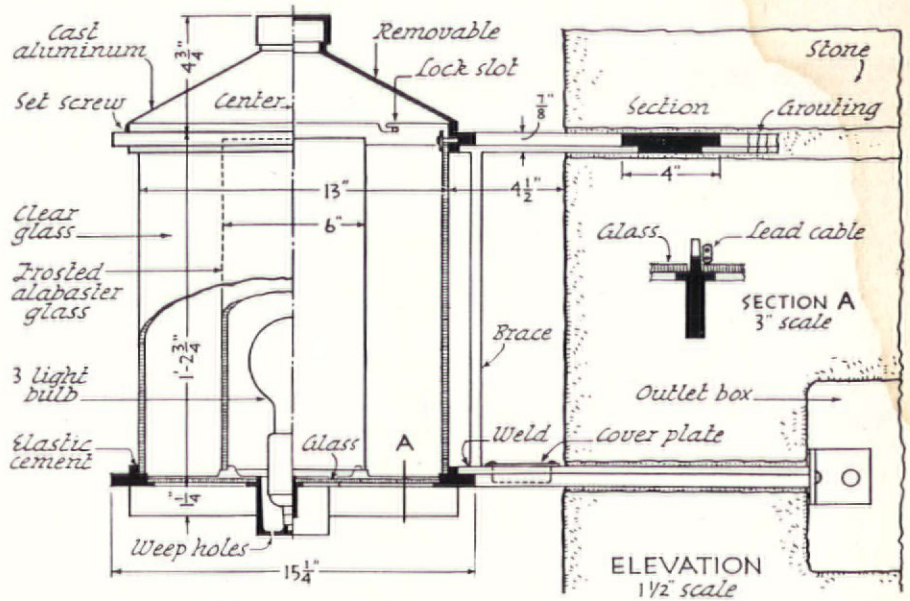

ERNEST A. GRUNSFELD, Jr. . . Architect

WALLACE F. YERKES . . . ASSOCIATE

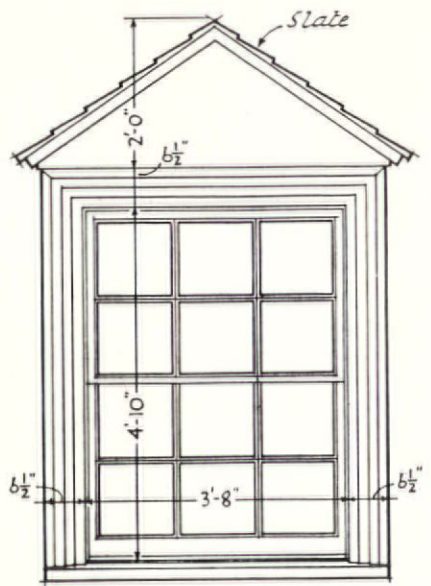
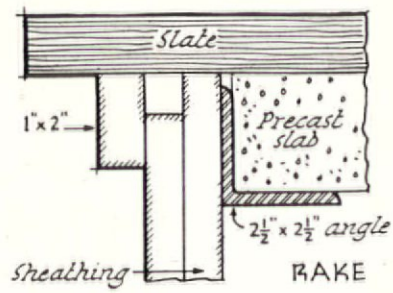
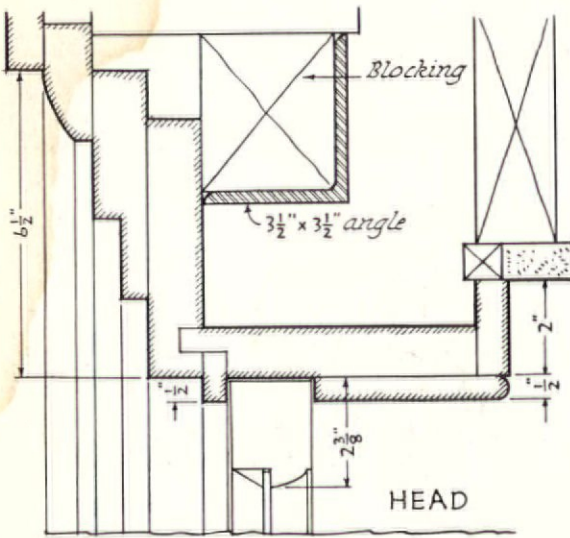

*Dormer Details*  
3" scale

DORMER ELEVATION  
3/8" scale

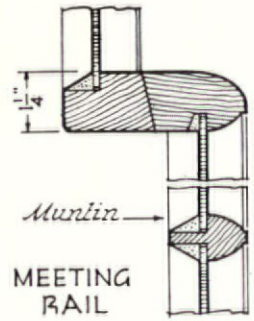
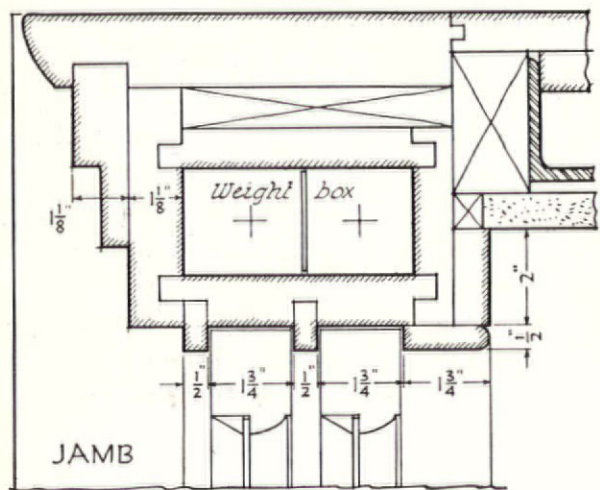

MAIN CORNICE  
3" scale

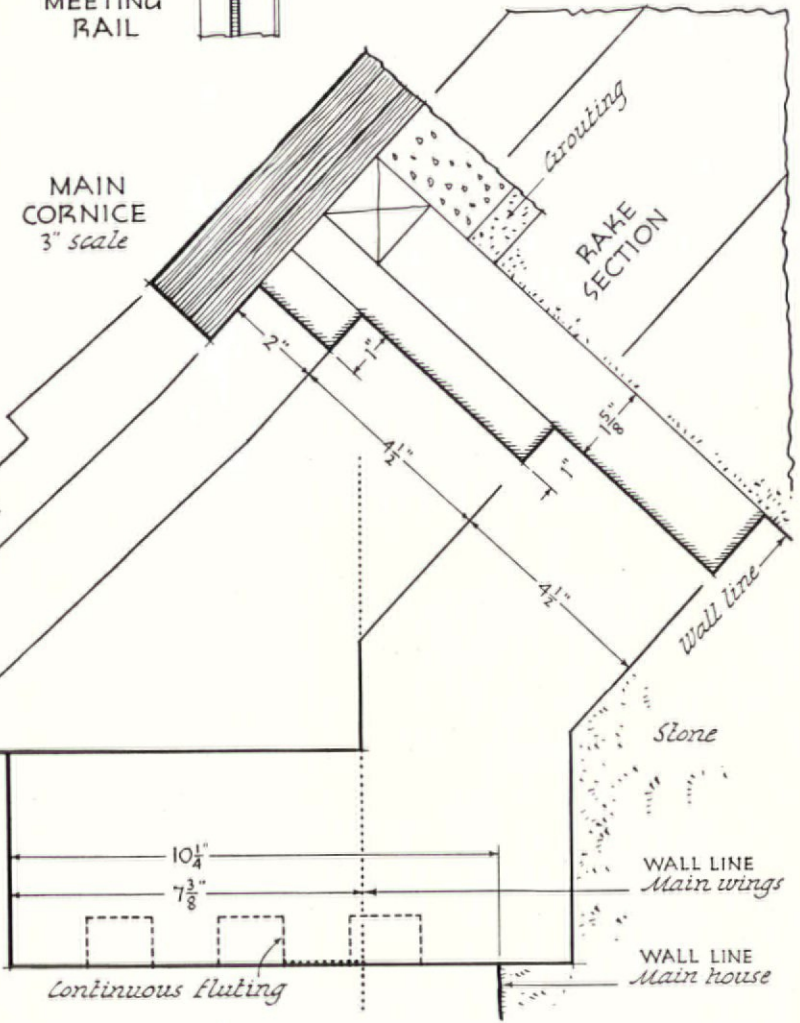
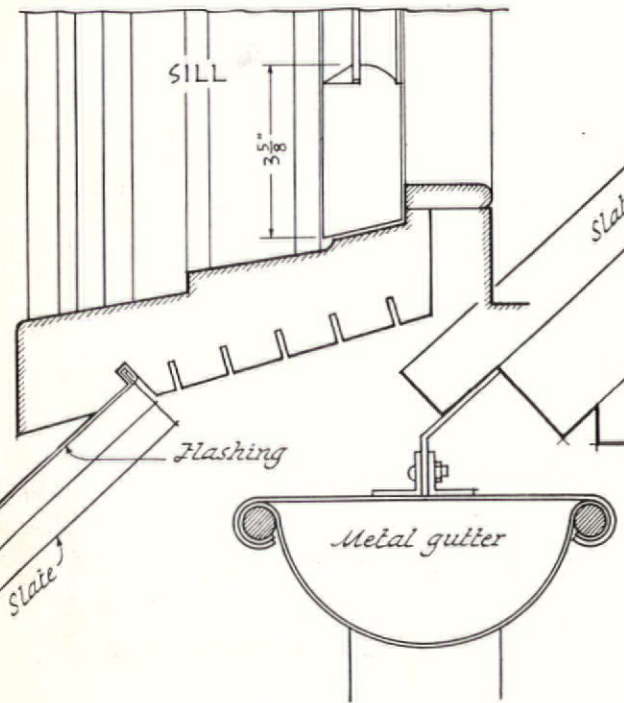

ERNEST A. GRUNSFELD, Jr. . . . *Architect* • WALLACE F. YERKES . . . . ASSOCIATE

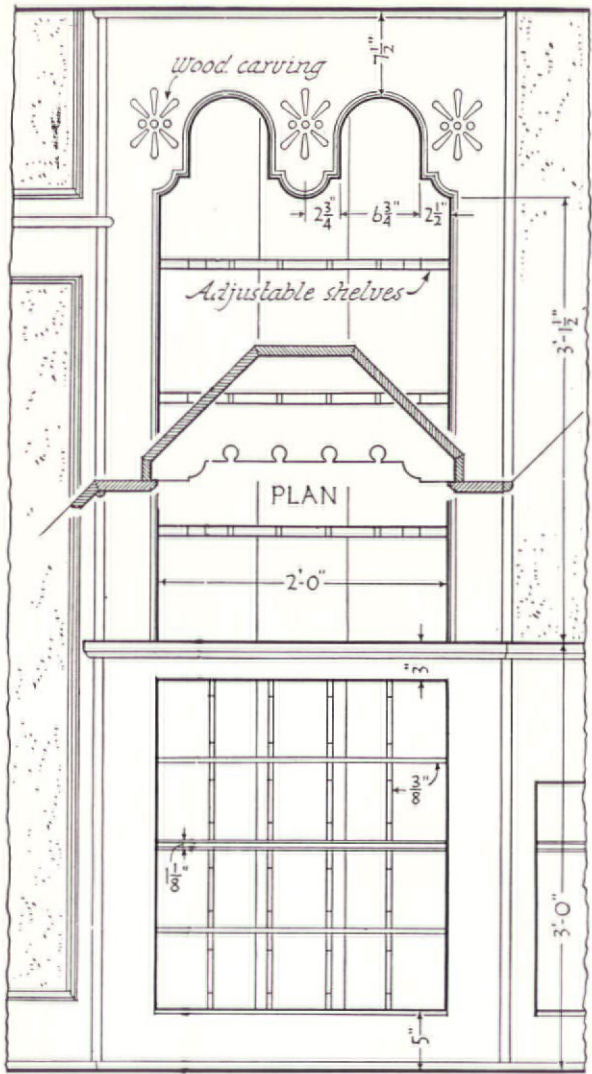

CUPBOARD ELEVATION 3/4" scale

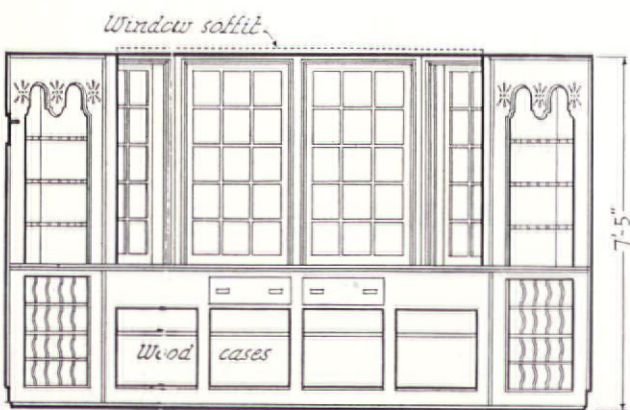

ELEVATION 1/4" scale



GEORGE H. VAN ANDA

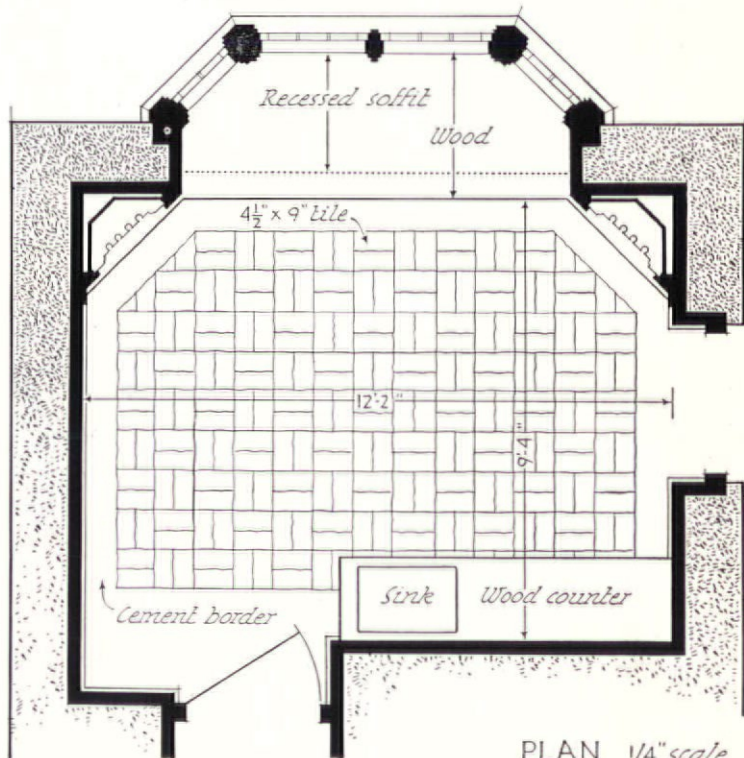

PLAN 1/4" scale

HEATHCOTE M. WOOLSEY  
Architect

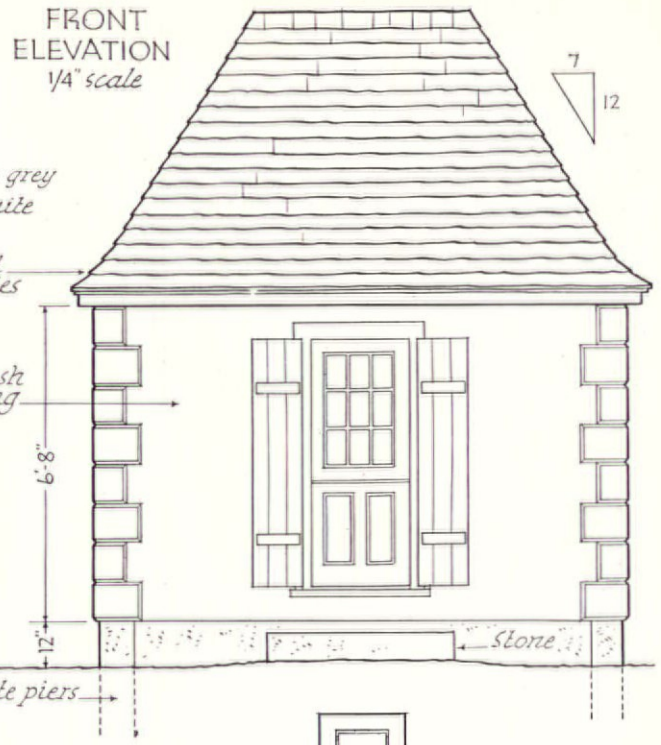
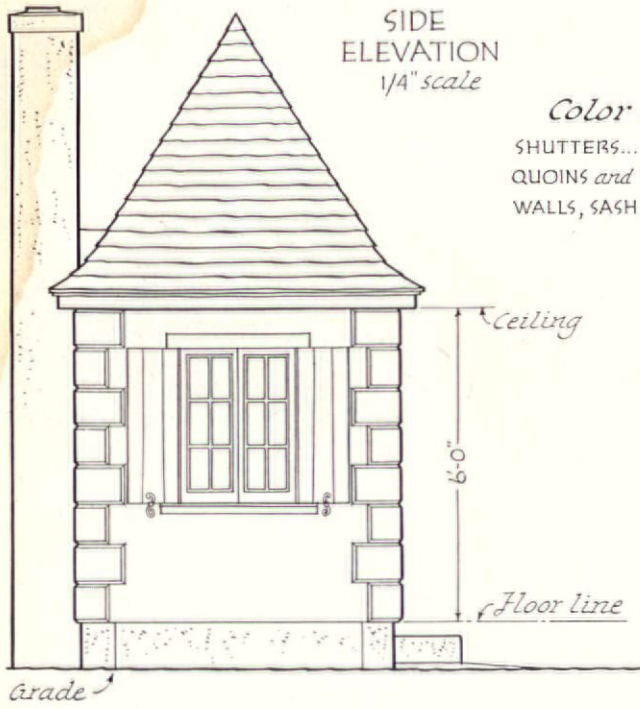

*Color scheme*  
 SHUTTERS... *Pale blue*  
 QUOINS and TRIM... *French grey*  
 WALLS, SASH, CORNICE... *White*

HENRY P. STAATS . . . . . *Architect.*

*Photos by VAN ANDA*

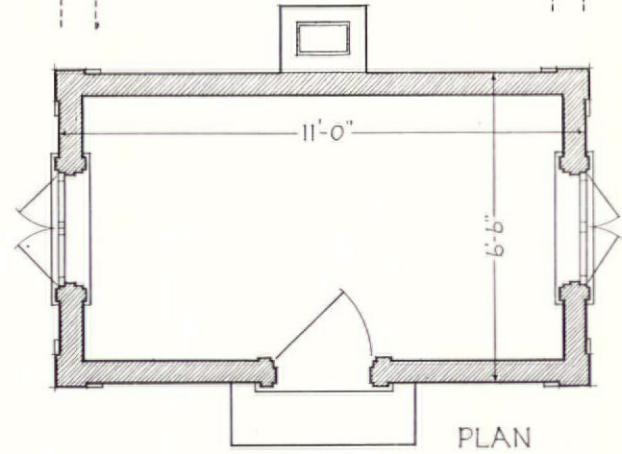

SELECTED ARCHITECTURAL DETAILS—FILLING STATIONS

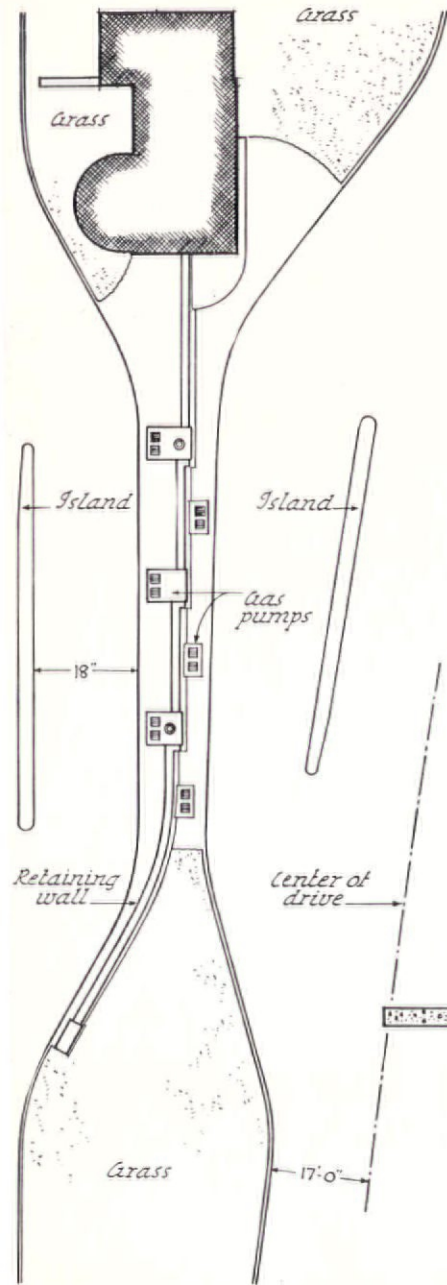
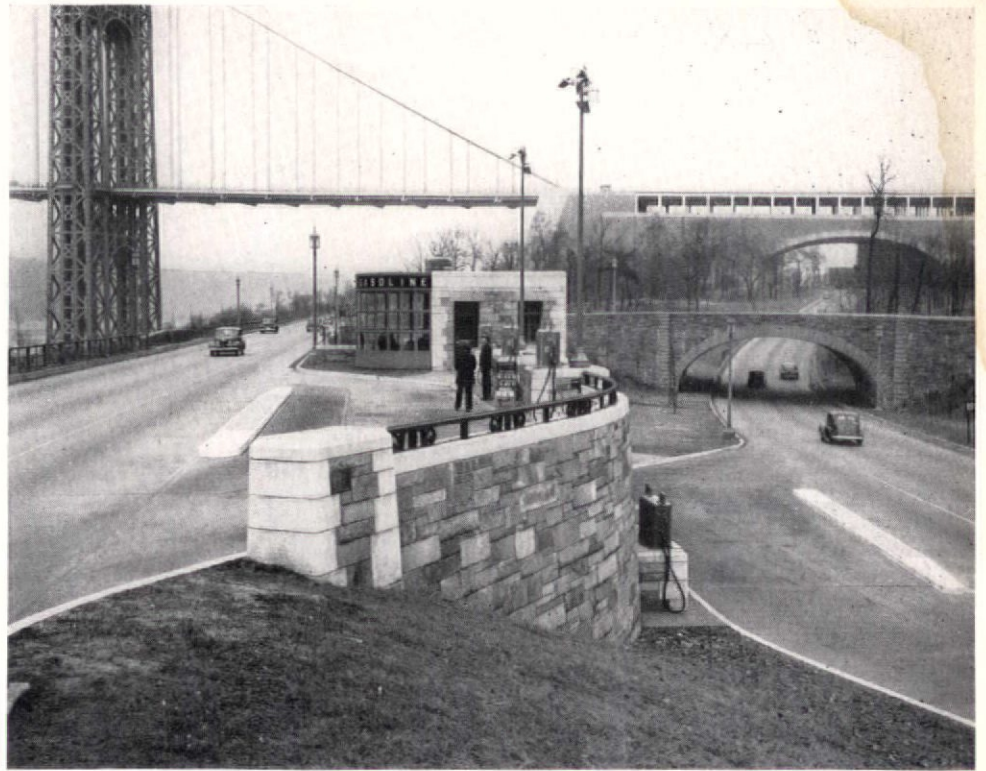

PLOT PLAN  
1/32" scale

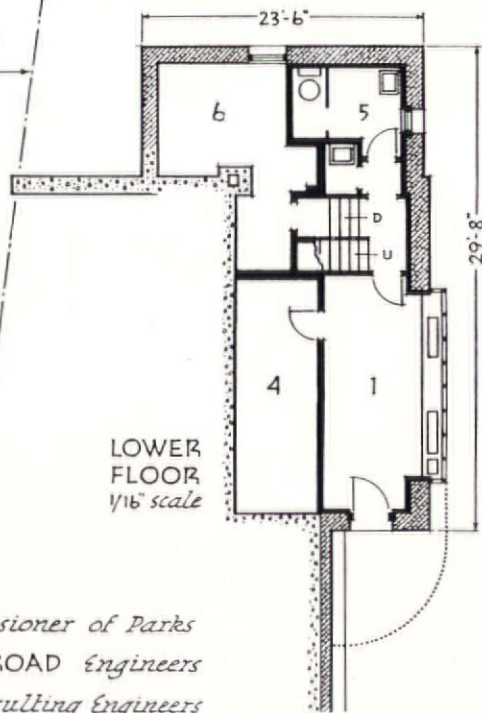

LOWER FLOOR  
1/16" scale

UPPER FLOOR  
1/16" scale

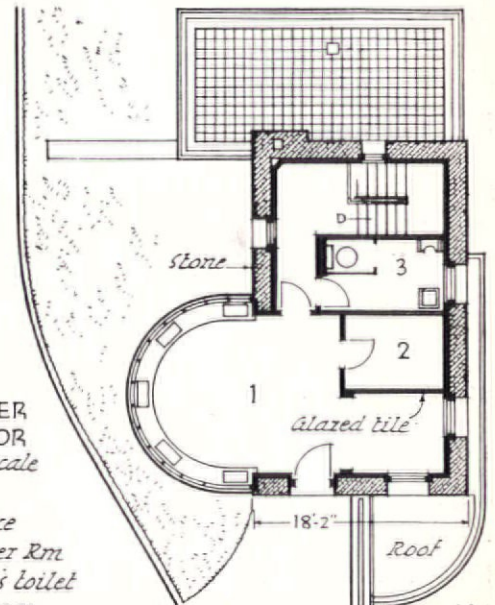

- 1 Office
- 2 Locker Rm
- 3 Men's toilet
- 4 Storage
- 5 Women's toilet
- 6 Boiler Room

ROBERT MOSES *Commissioner of Parks*  
 NEW YORK CENTRAL RAILROAD *Engineers*  
 MADIGAN-HYLAND *Consulting Engineers*

ELEVATION *From upper drive* 1/16" scale

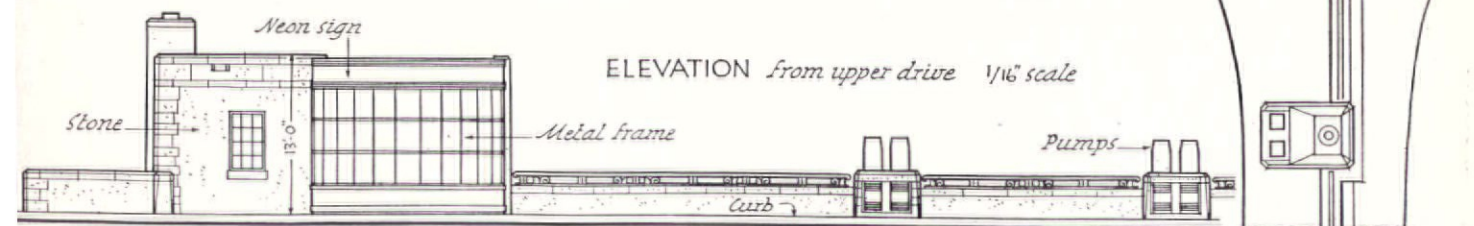

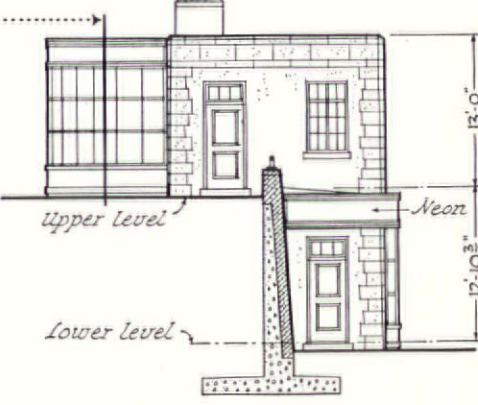
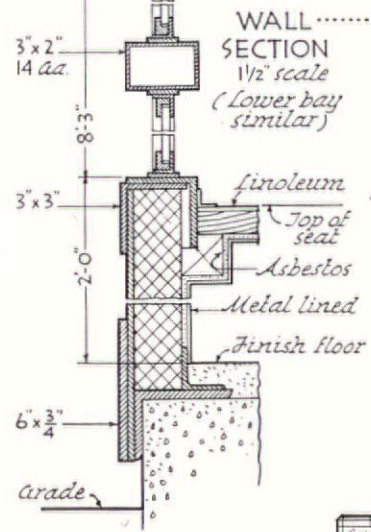
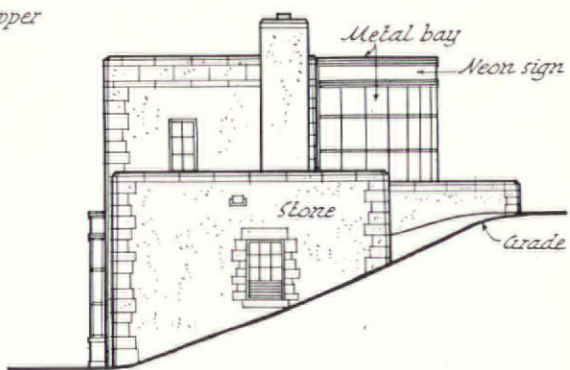
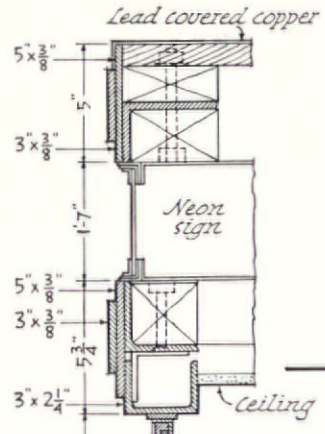
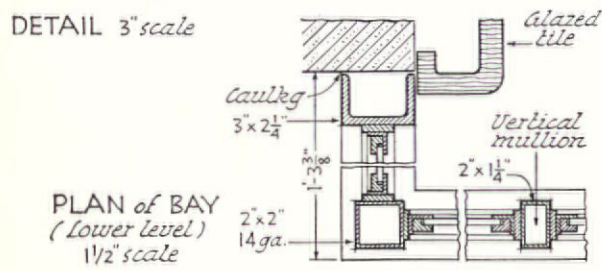
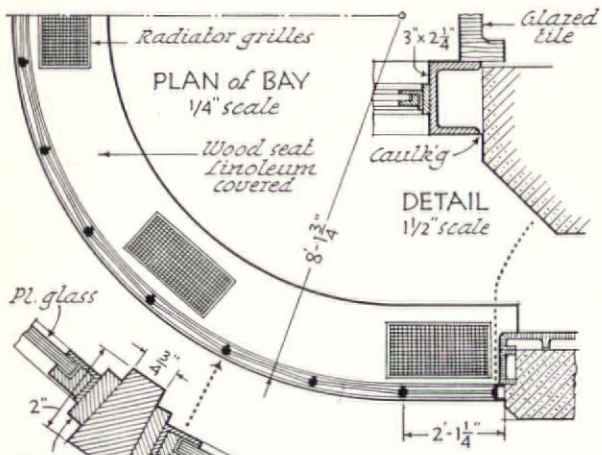
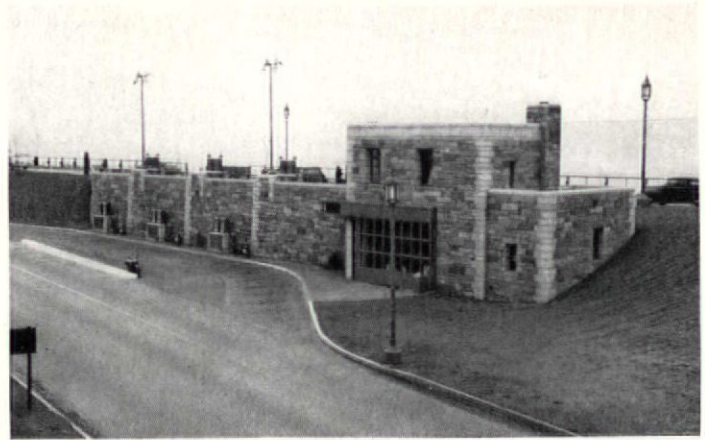

ROBERT MOSES *Commissioner of Parks*  
 NEW YORK CENTRAL RAILROAD *Engineers*  
 MADIGAN - HYLAND *Consulting Engineers*

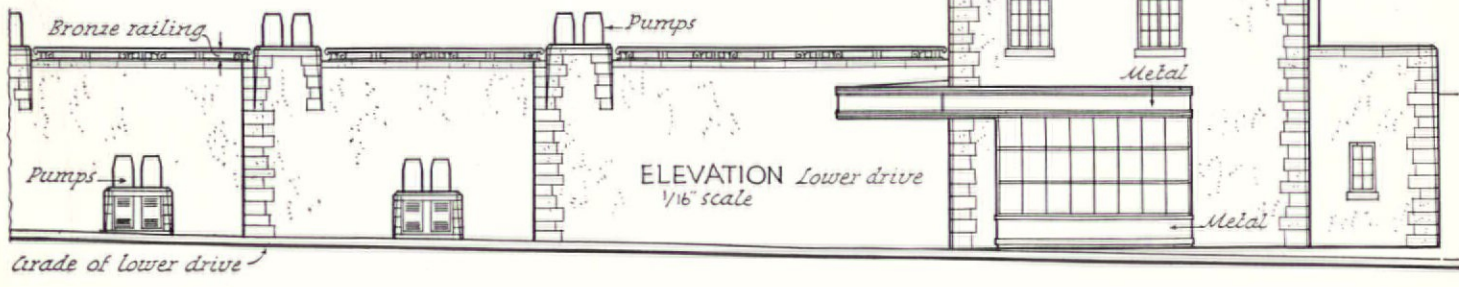





SELECTED ARCHITECTURAL DETAILS—TVA DETAILS

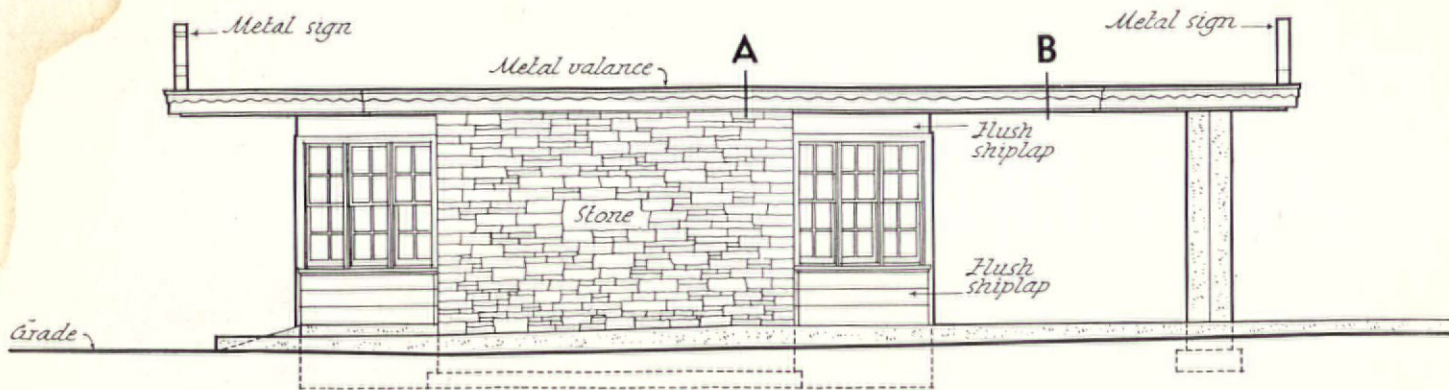

SIDE ELEVATION

All elevations at 1/8" scale.

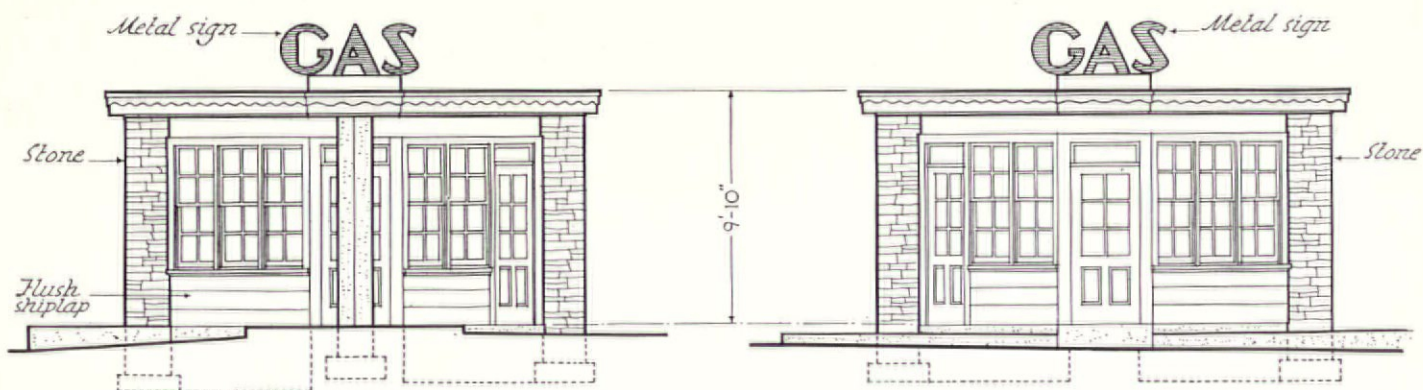

END ELEVATION

END ELEVATION

NOTE. See preceding page for plan

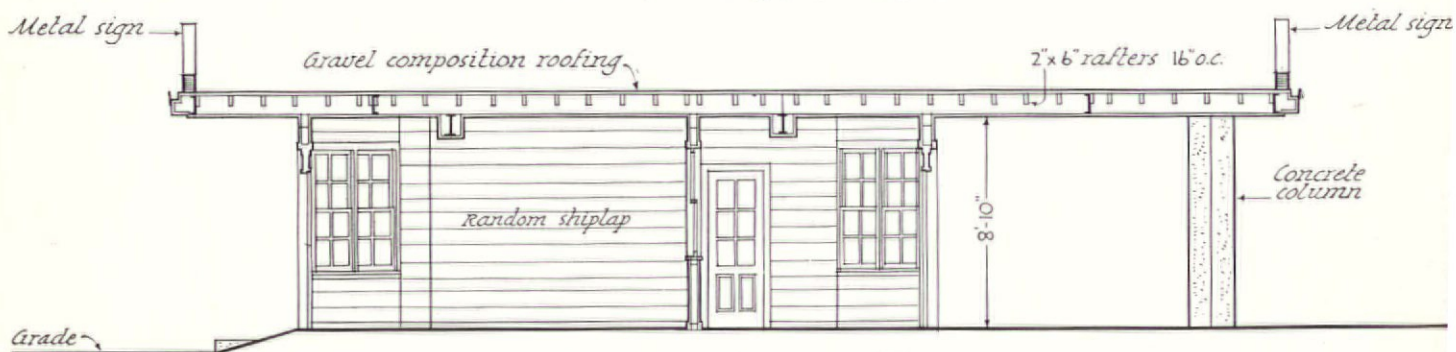

LONGITUDINAL SECTION

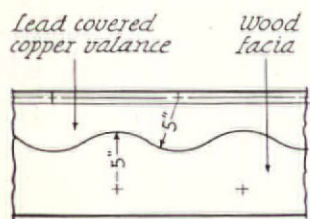

ELEVATION

SECTION A 3/4" scale

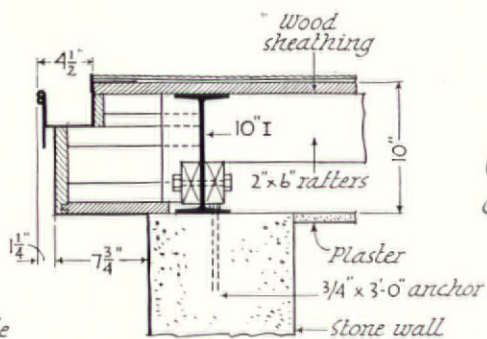

Cornice details

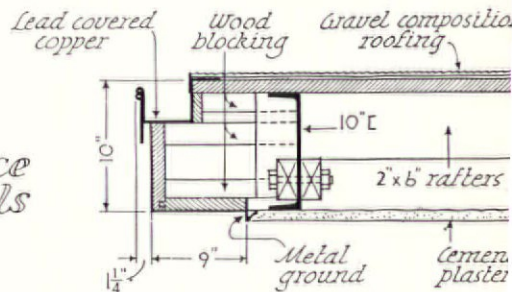

SECTION B 3/4" scale

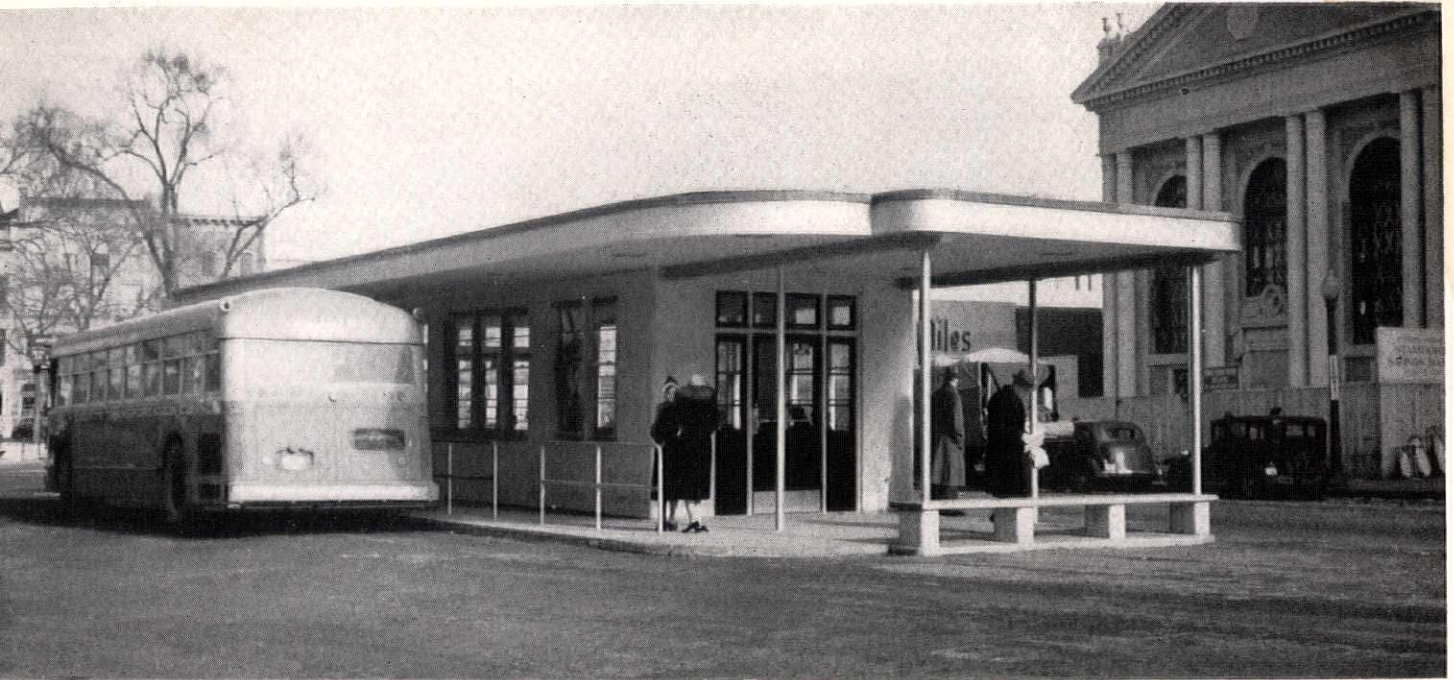

KENNETH REID

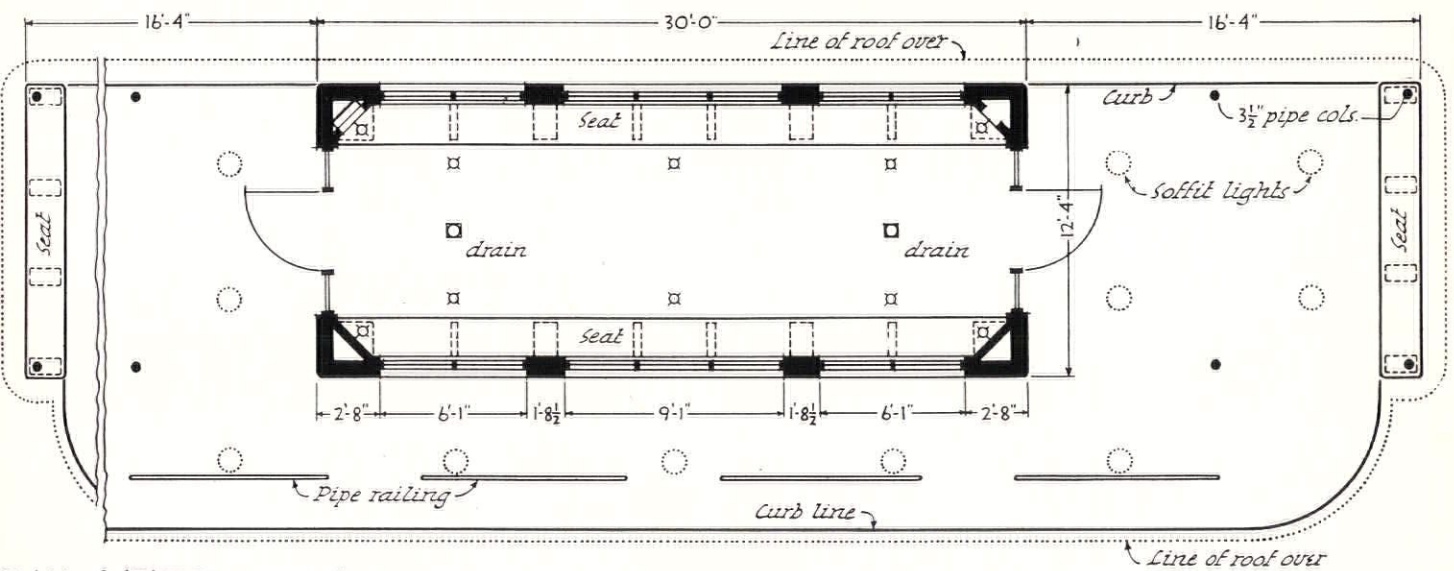

PLAN of STATION 1/8" scale

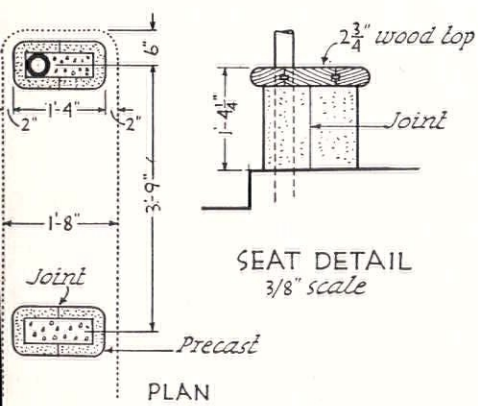

SEAT DETAIL  
3/8" scale

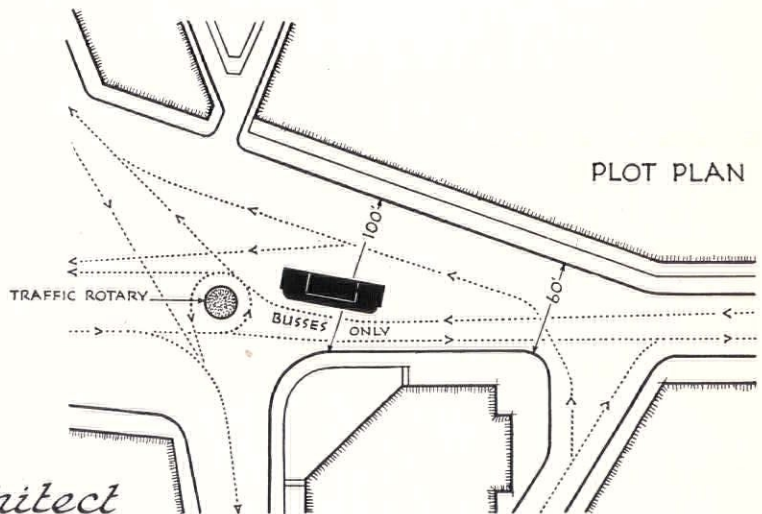

PLOT PLAN

DAVID C. SANFORD, Jr., . . . Architect

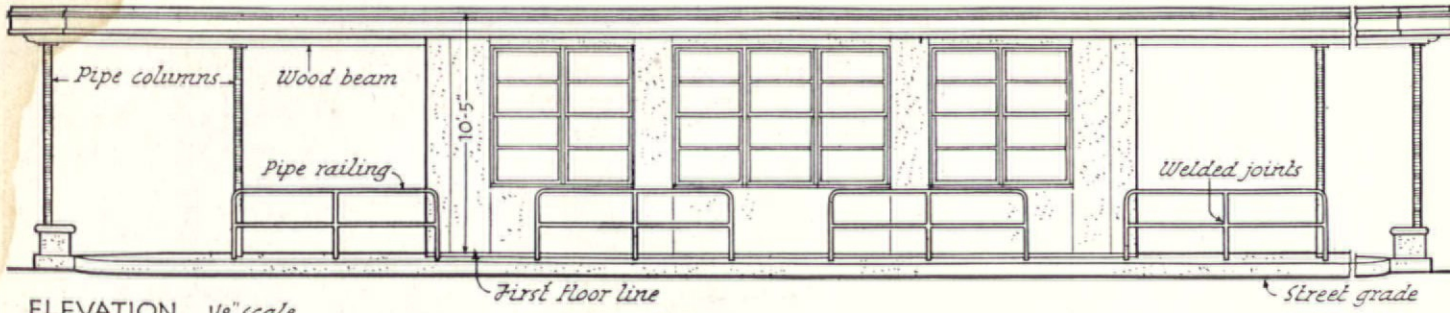

ELEVATION 1/8" scale

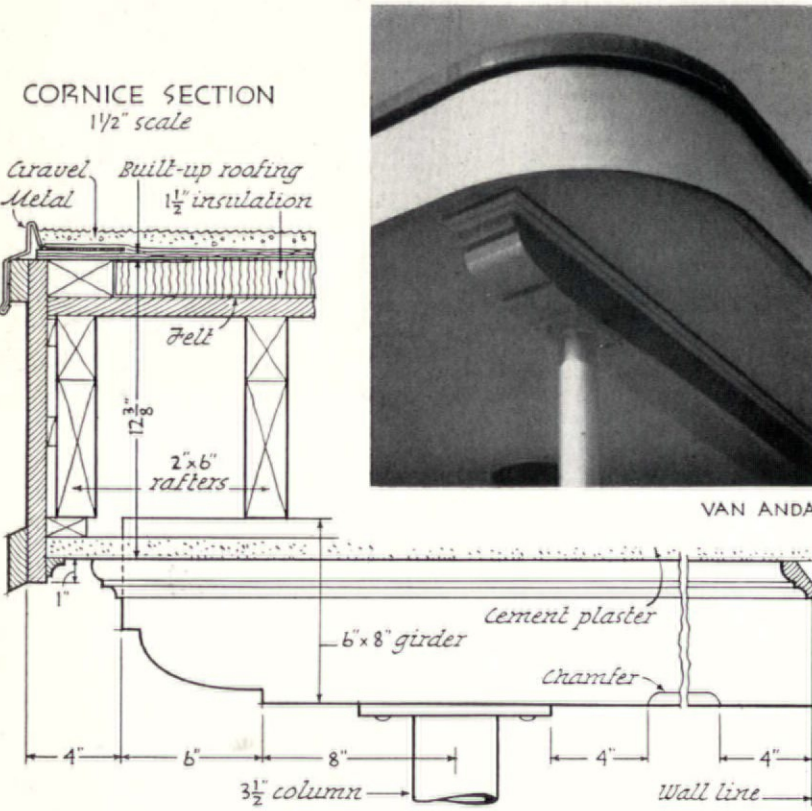

CORNICE SECTION 1/2" scale

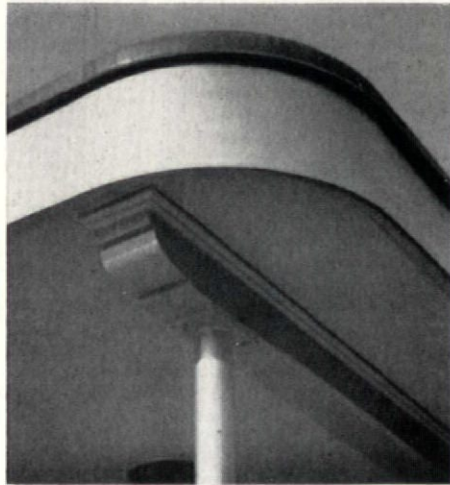

VAN ANDA

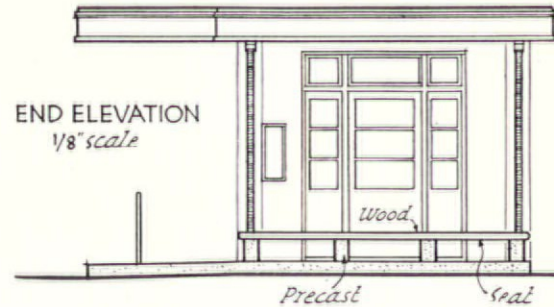

END ELEVATION 1/8" scale

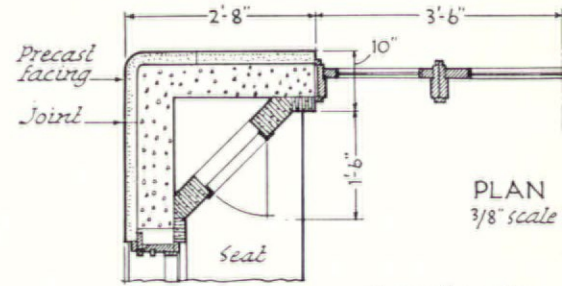

PLAN 3/8" scale

KENNETH REID

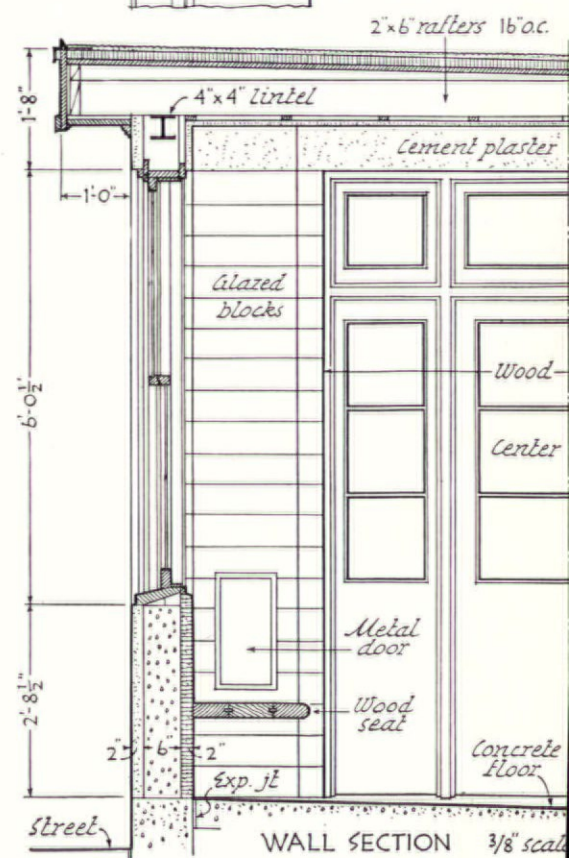

WALL SECTION 3/8" scale

DAVID C. SANFORD, Jr., . . . Architect

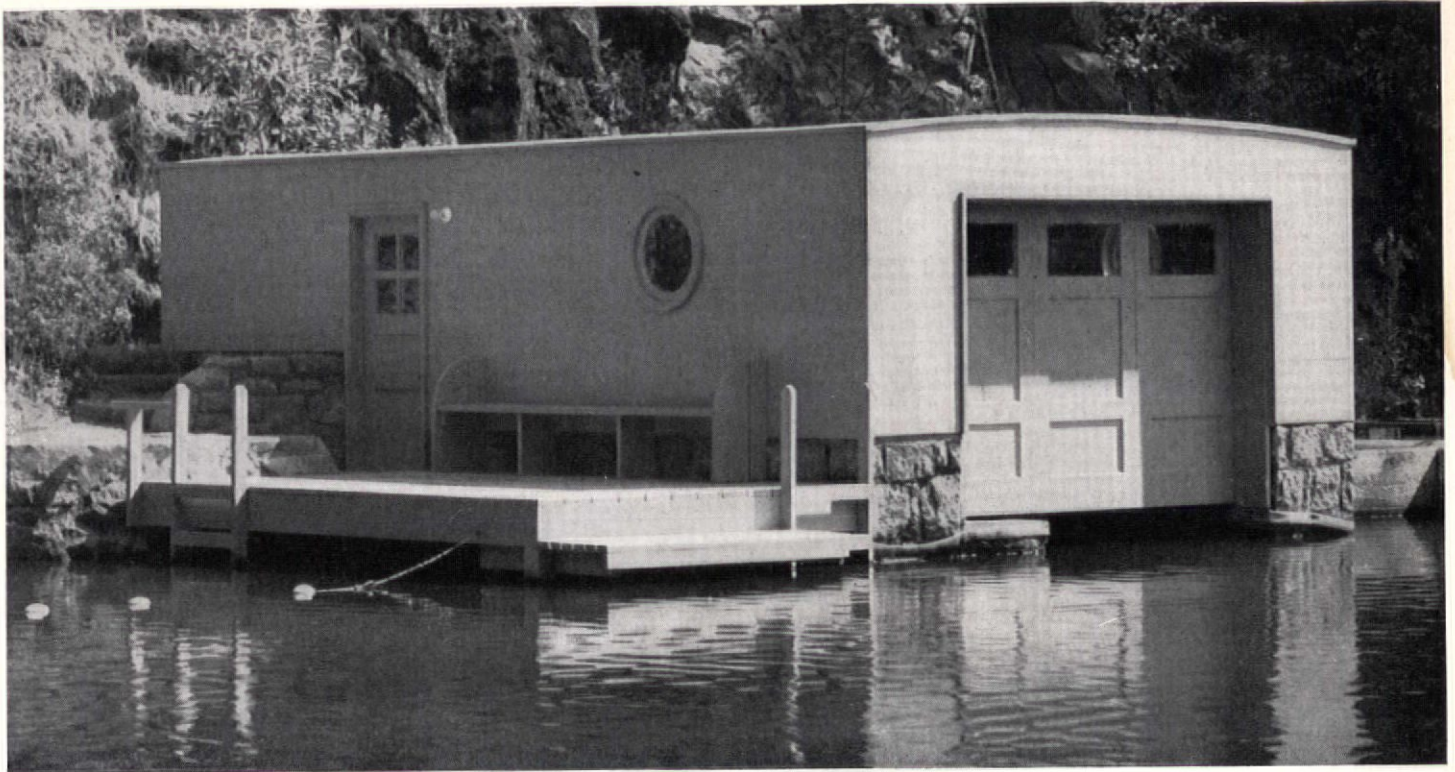

W. BOYCHUK



FRONT ELEVATION 1/8" scale

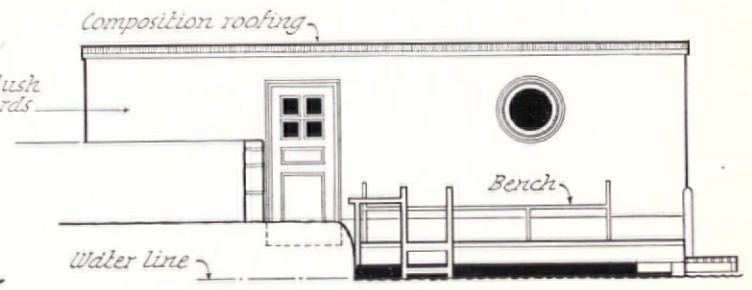

SIDE ELEVATION 1/8" scale

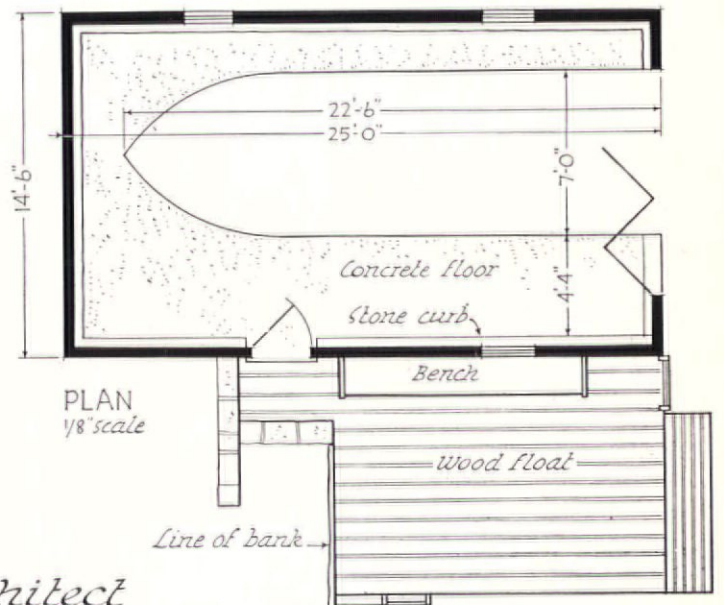

PLAN 1/8" scale

GLENN STANTON . . . . . Architect



C. E. ENGELBRECHT

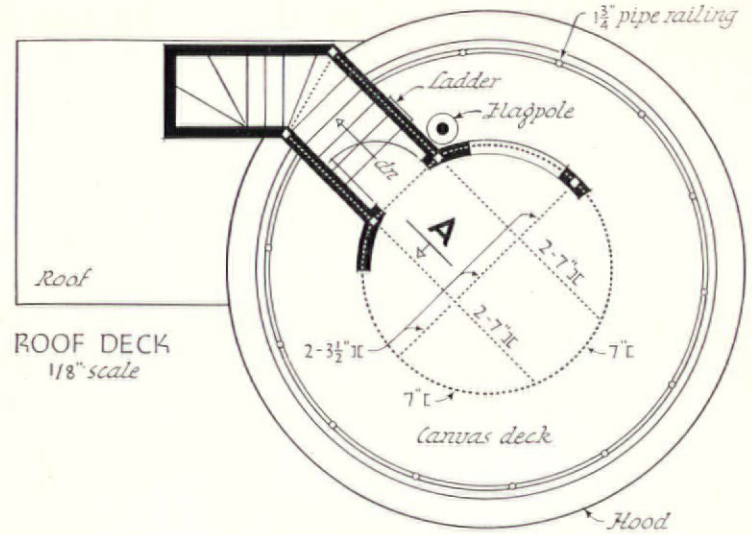

ROOF DECK  
1/8" scale

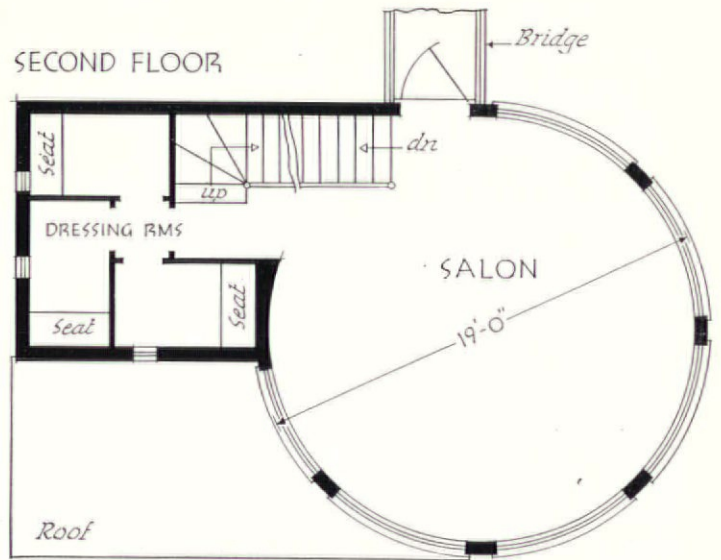

SECOND FLOOR

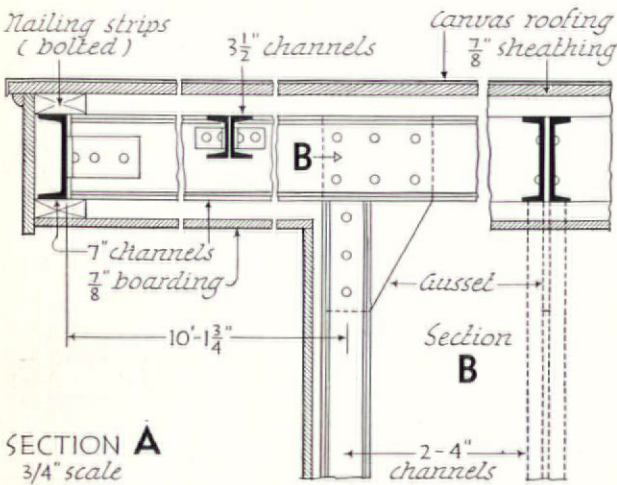

SECTION A  
3/4" scale

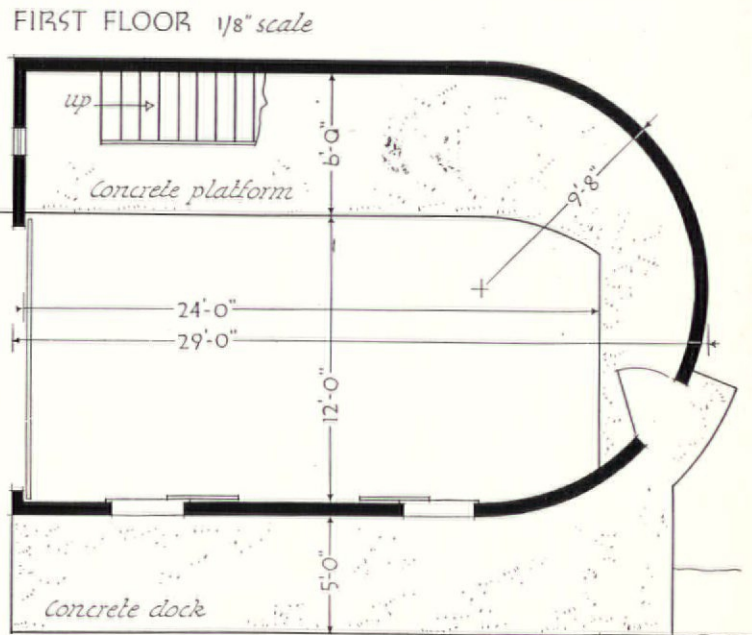

FIRST FLOOR 1/8" scale

SIMPSON & ROLSTON  
*Architects*

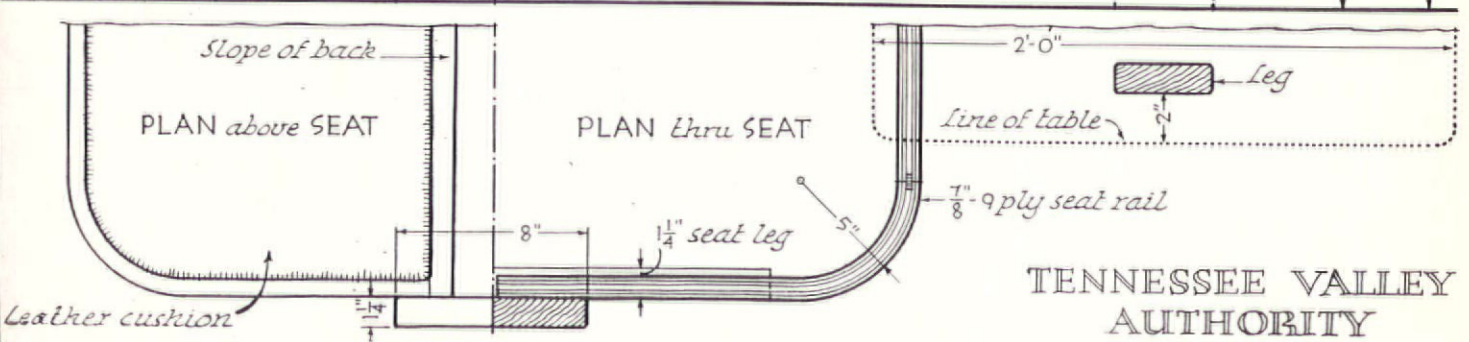
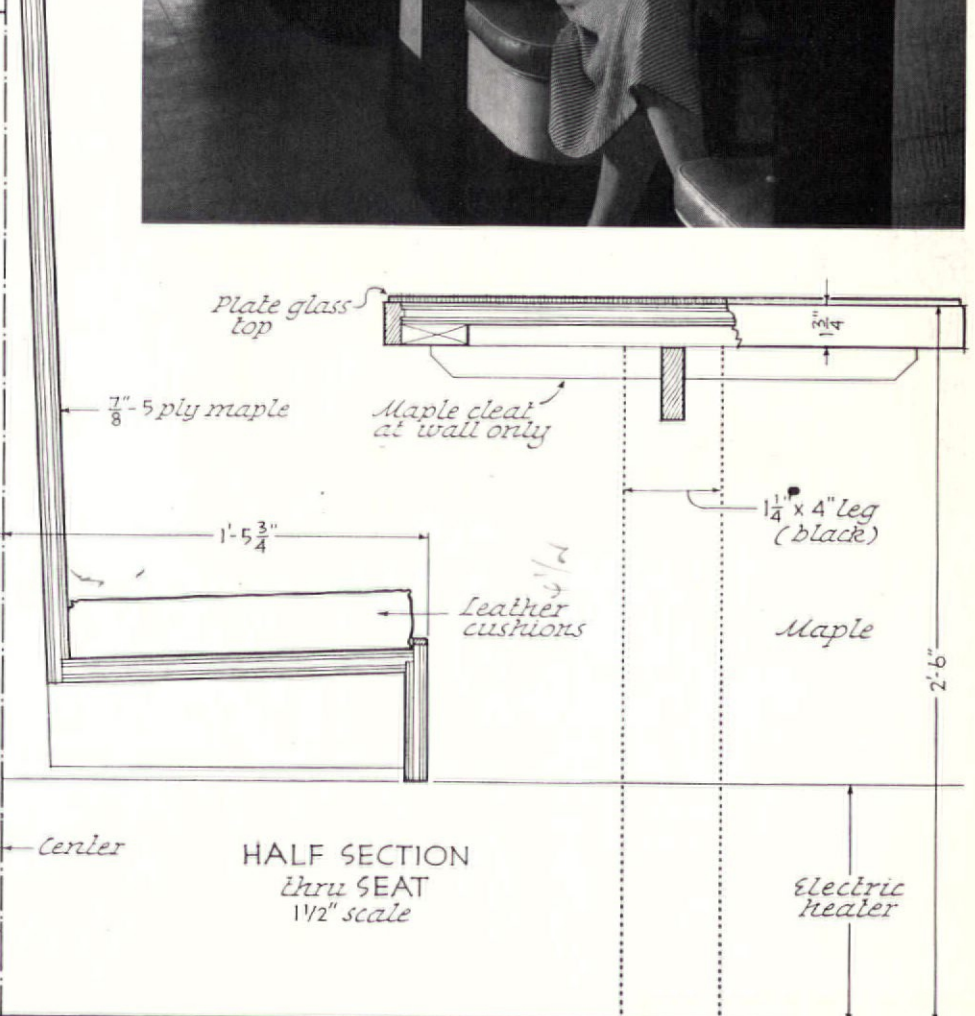
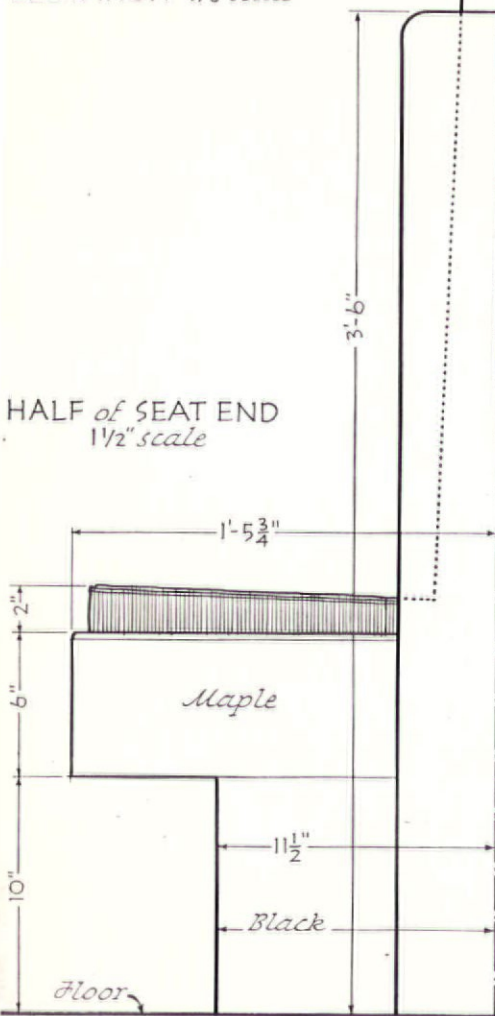
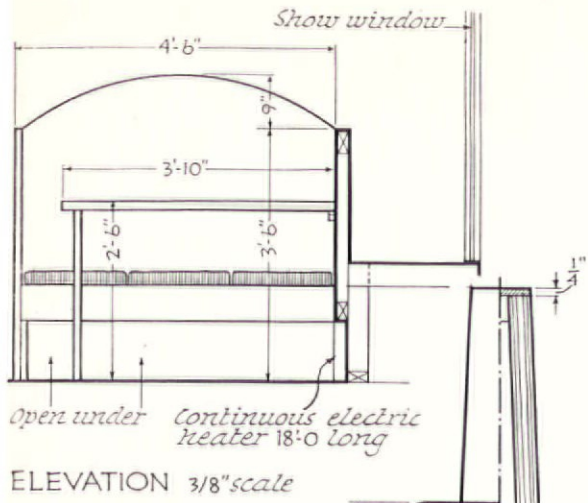

TENNESSEE VALLEY  
AUTHORITY



ROBERT M. DAMORA

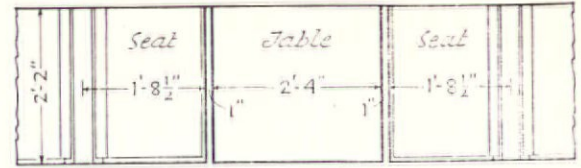

PLAN of SEATS 3/8" scale

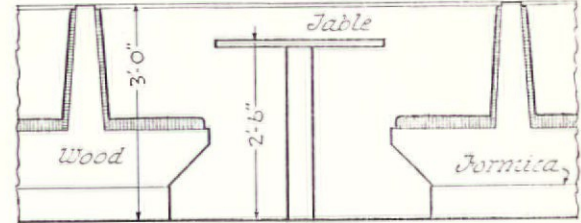

ELEVATION of SEATS

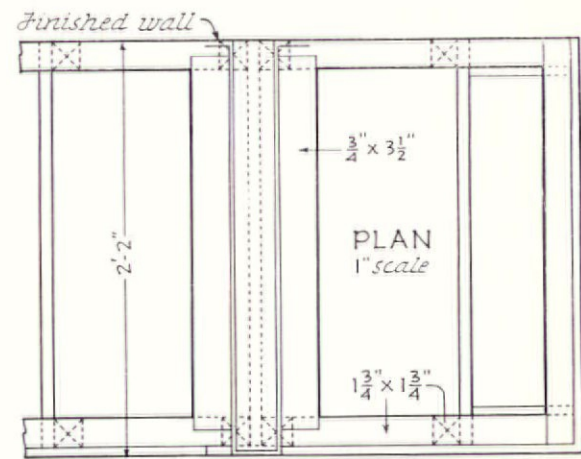

PLAN 1" scale

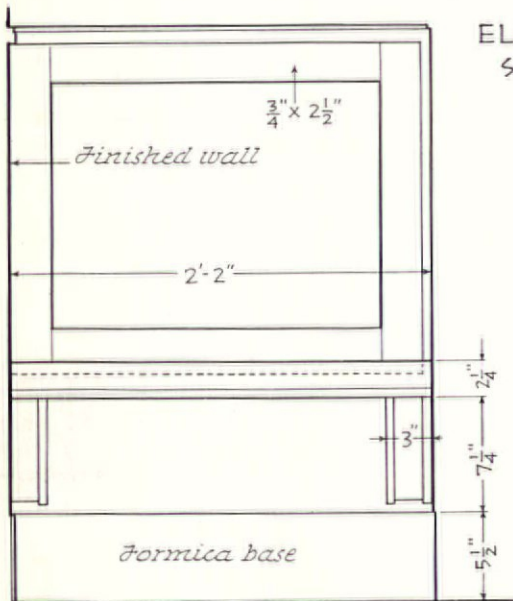

ELEVATION of SEAT BACK 1" scale

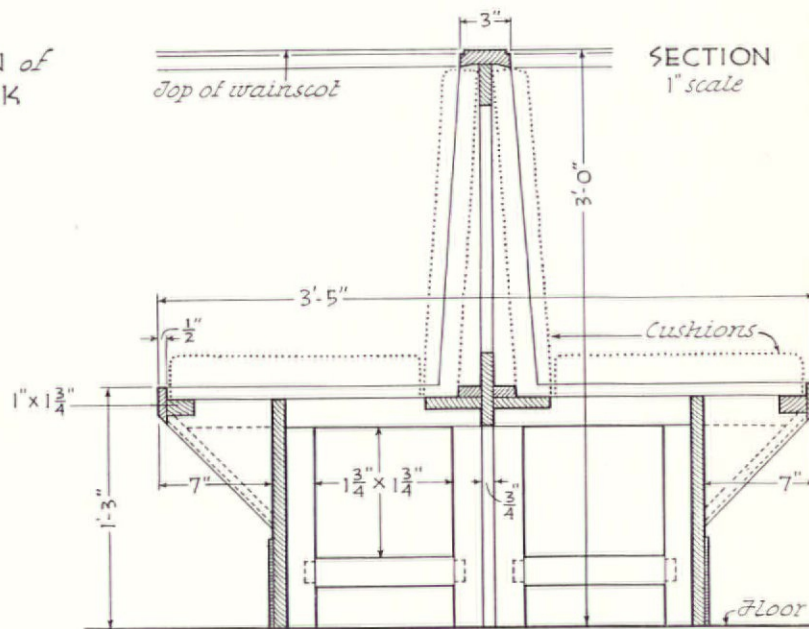

SECTION 1" scale

LOUIS ALLEN ABRAMSON . . . . . Architect



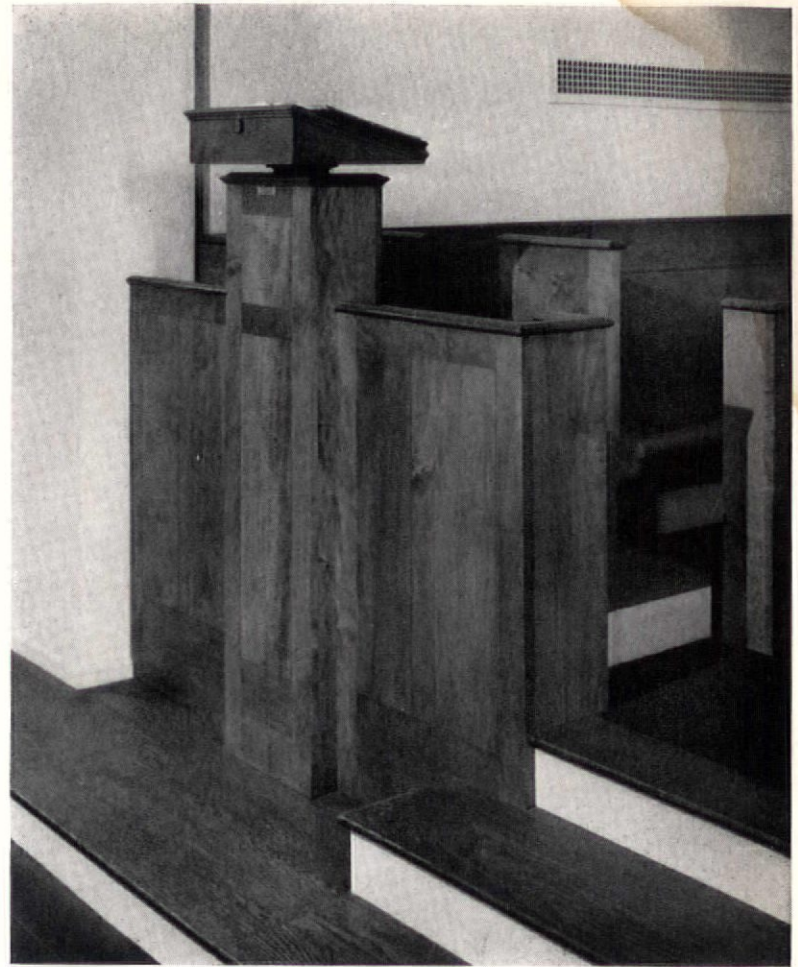
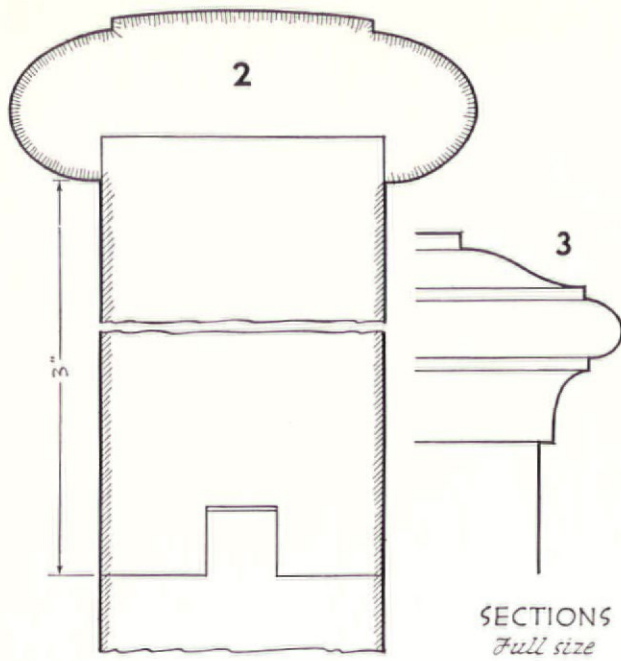

GEORGE H. VAN ANDA

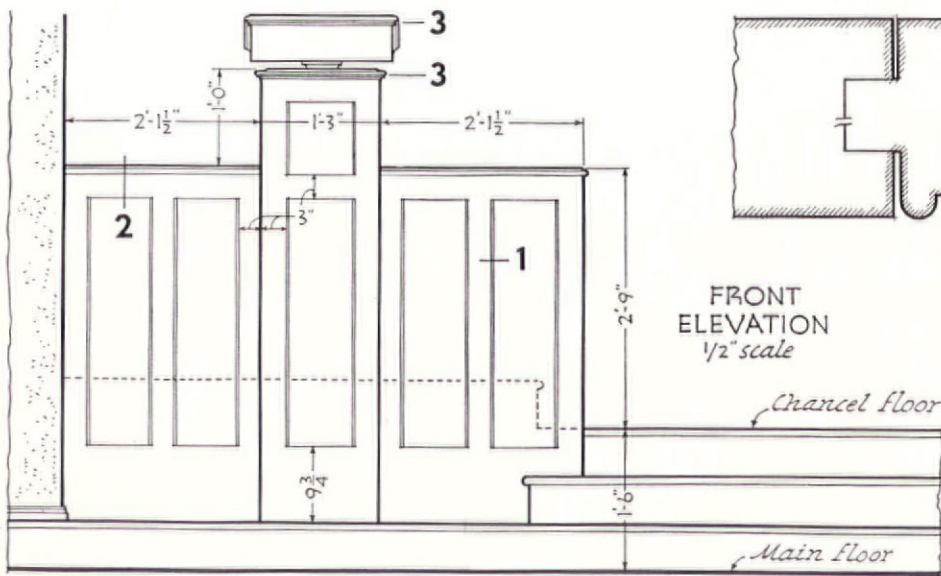
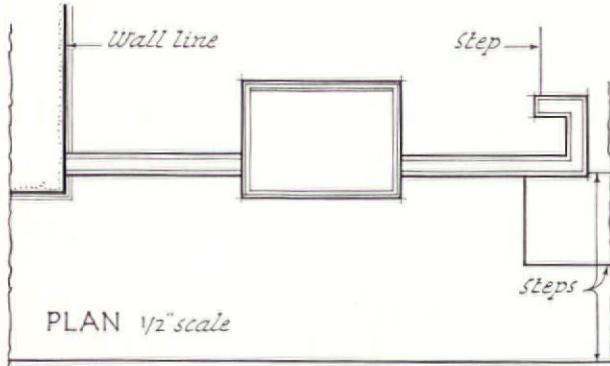

SECTION 1 Full size

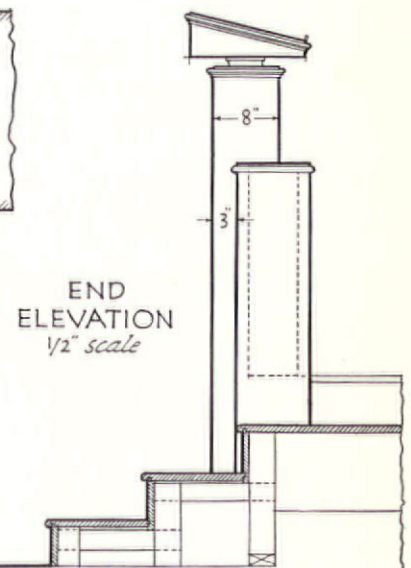
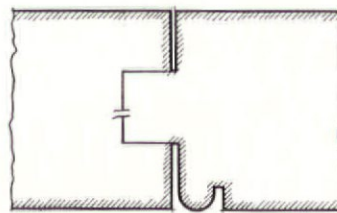

WILLIAM WEBB SUNDERLAND . . . . . Architect



GEORGE H. VAN ANDA

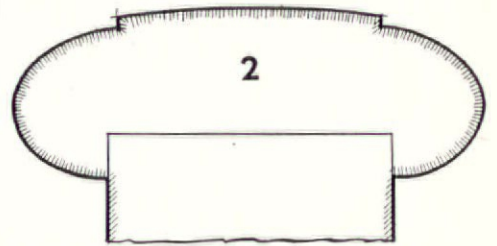
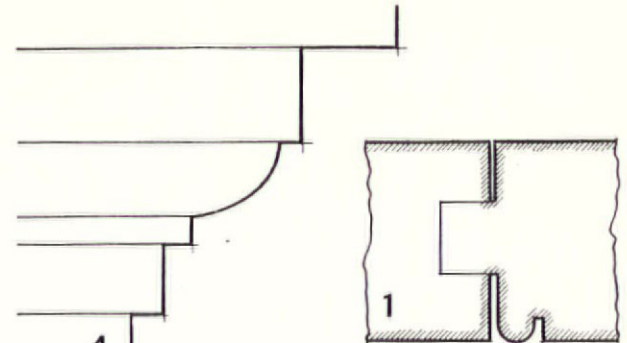
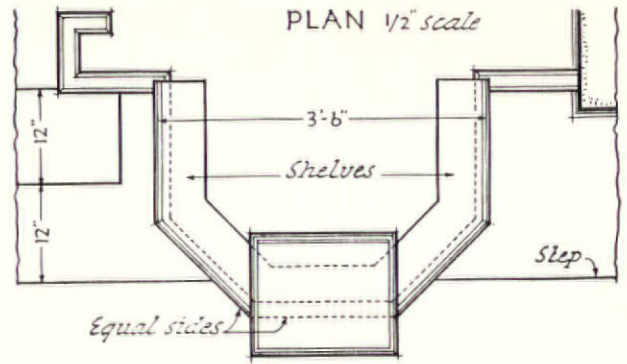

SIDE ELEVATION  $\frac{1}{2}$ " scale

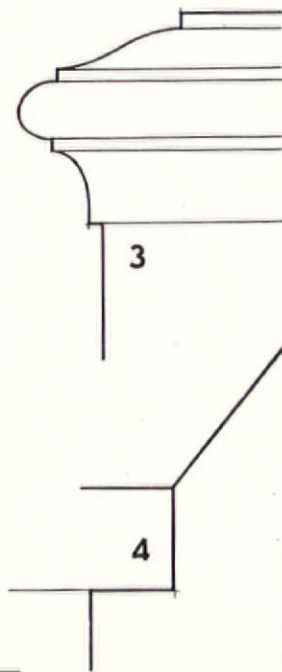
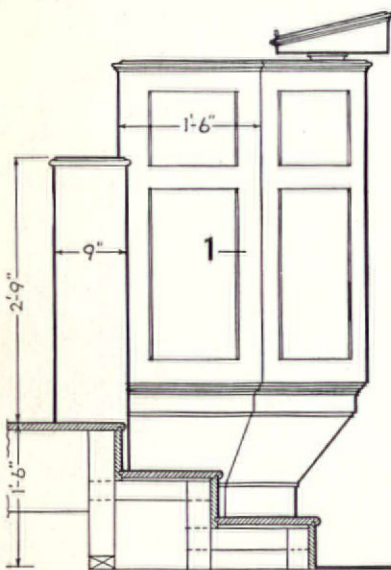

FRONT ELEVATION  $\frac{1}{2}$ " scale

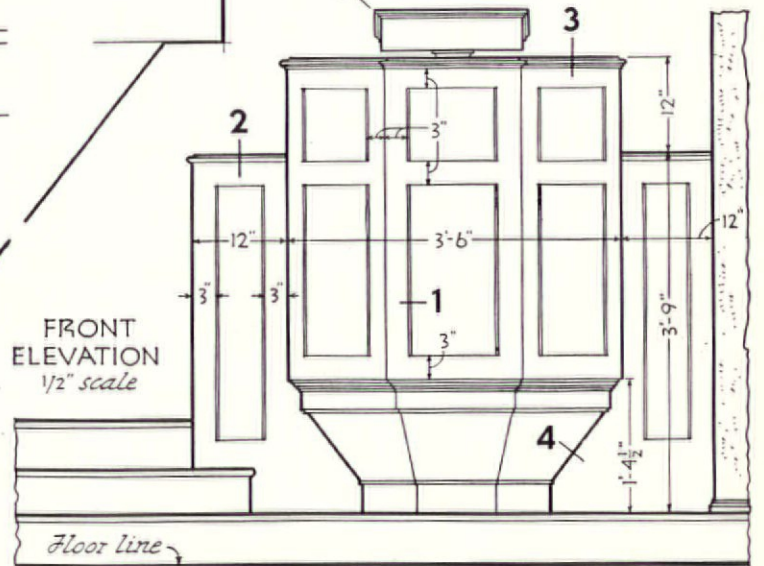

WILLIAM WEBB SUNDERLAND. . . . . Architect

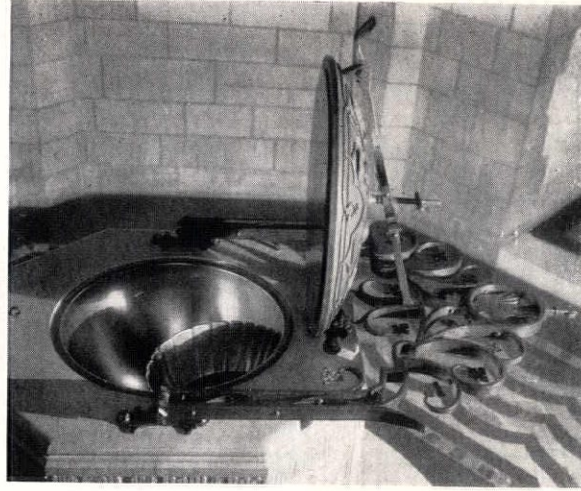

Photos by ADOLPH STUDLY Jr.

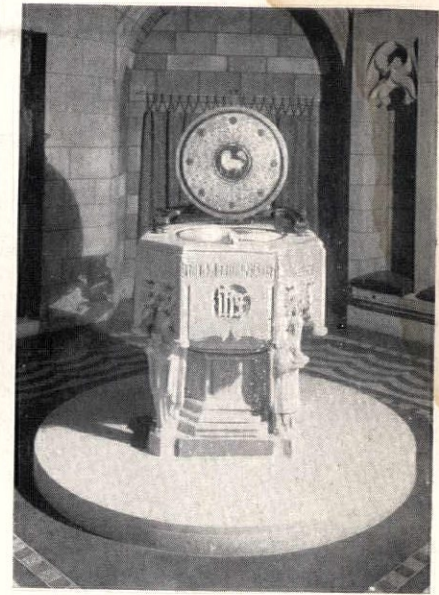

ELEVATION of IRONWORK  
1/2" scale

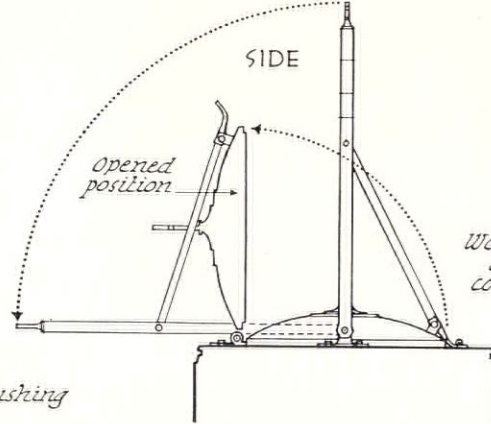
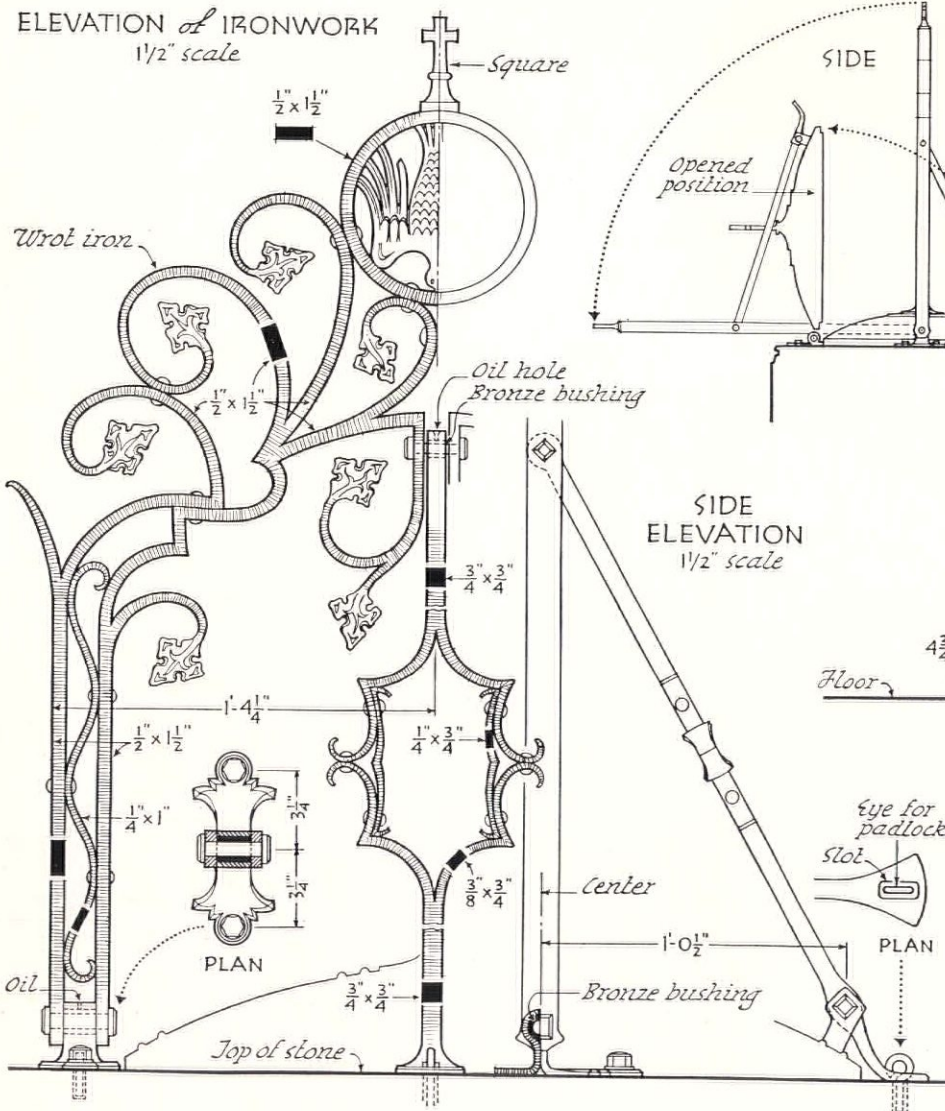

SIDE ELEVATION  
1/2" scale

FRONT ELEVATION  
1/2" scale

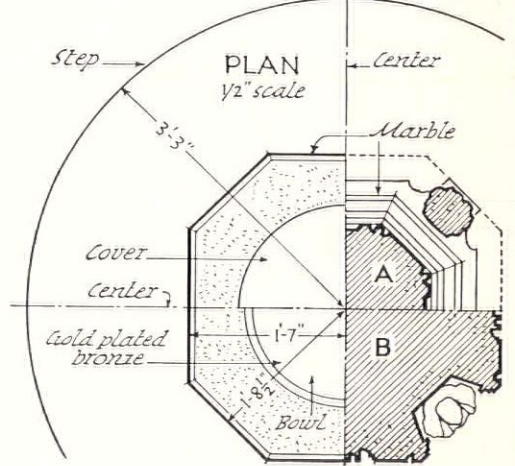
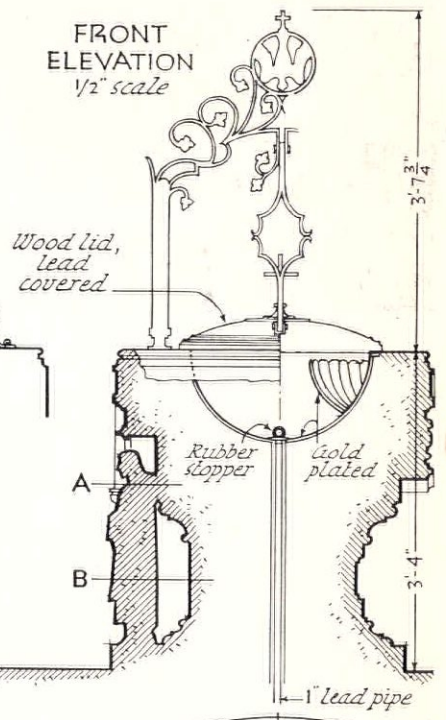

ELLIOTT L. CHISLING . . . . . Architect

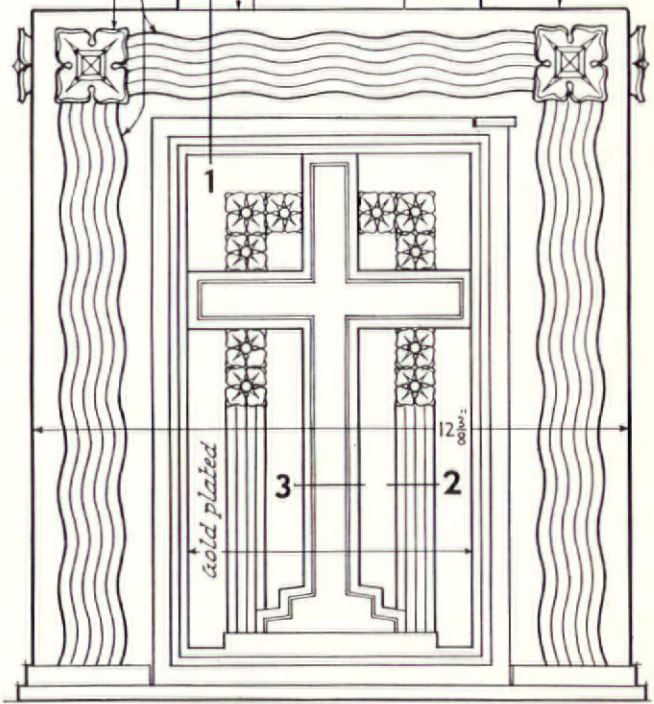
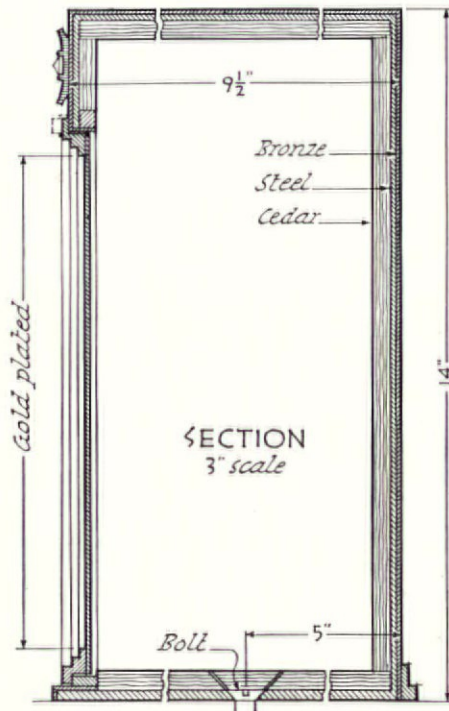
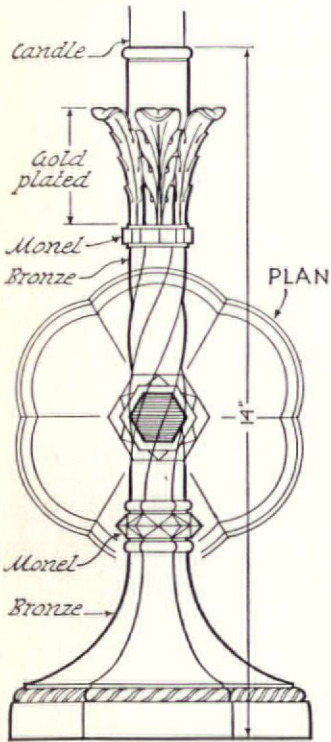
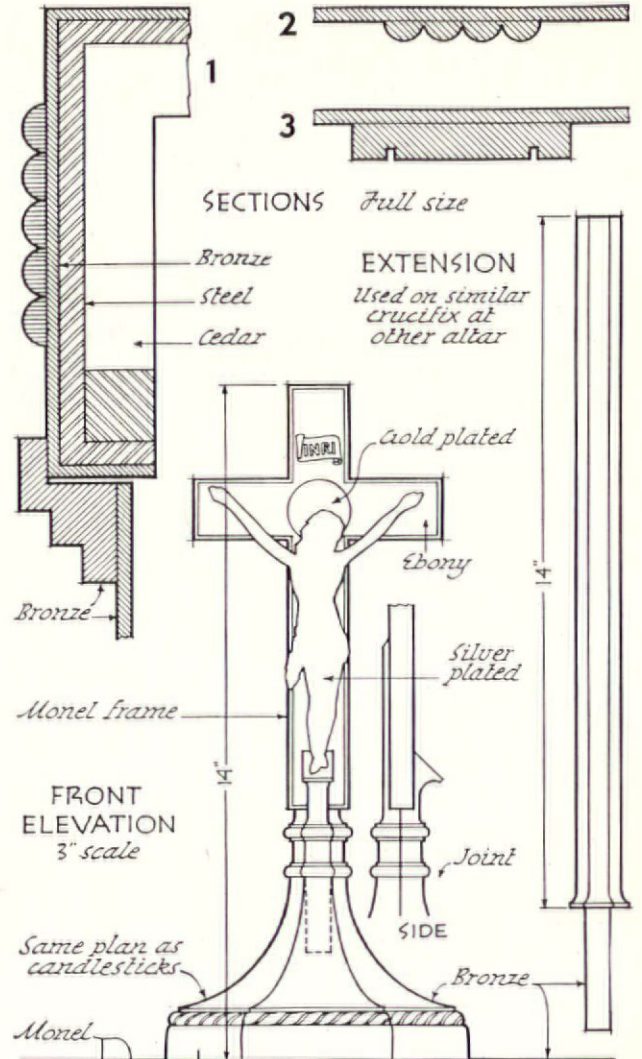

HENRY D. DAGIT & SONS . . . . . Architects

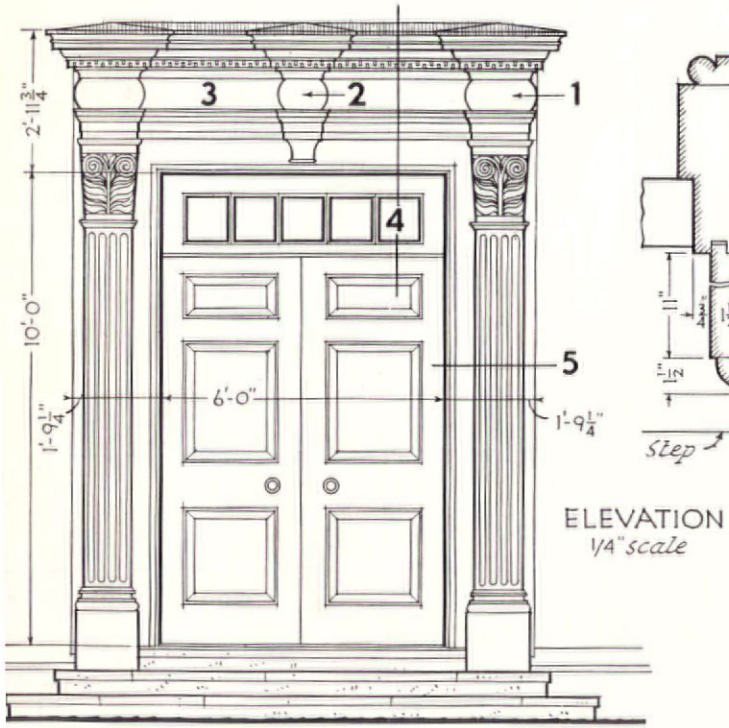
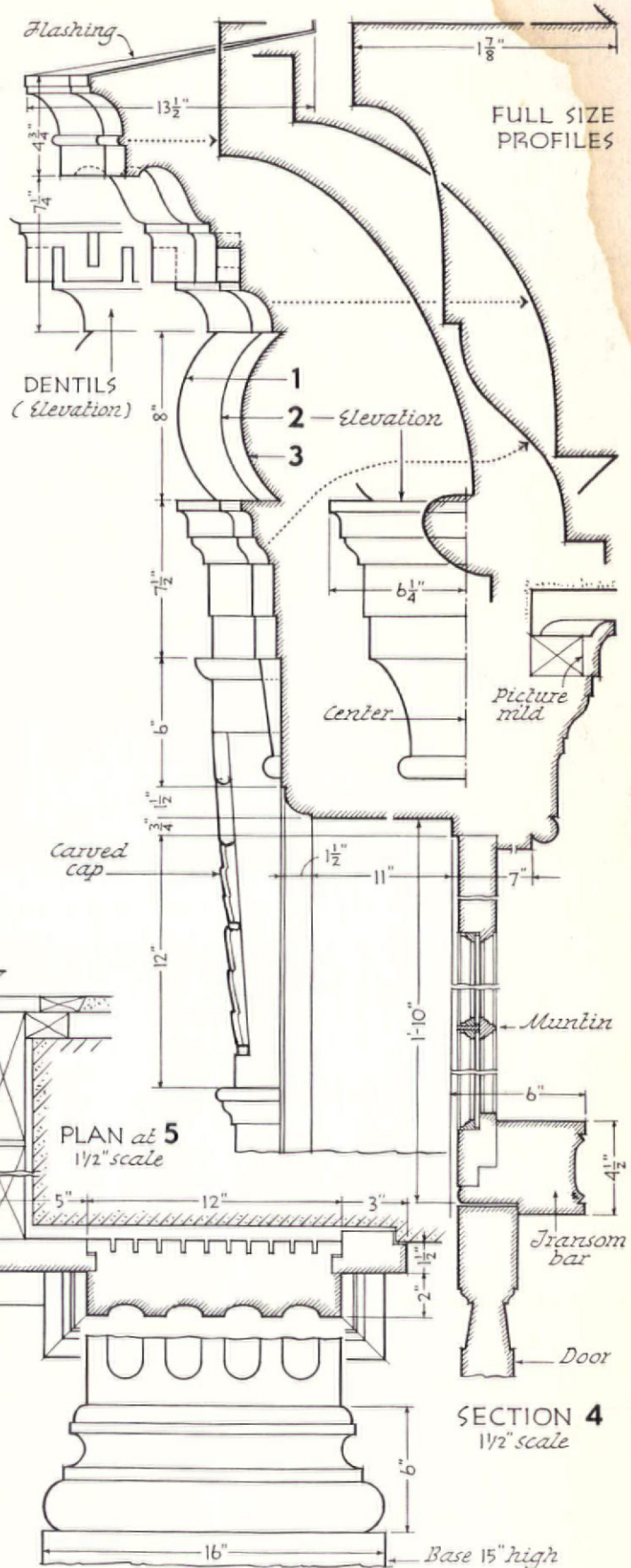

HOBART B. UPJOHN . . . *Architect*

OTTO F. LANGMANN . . . ASSOCIATE

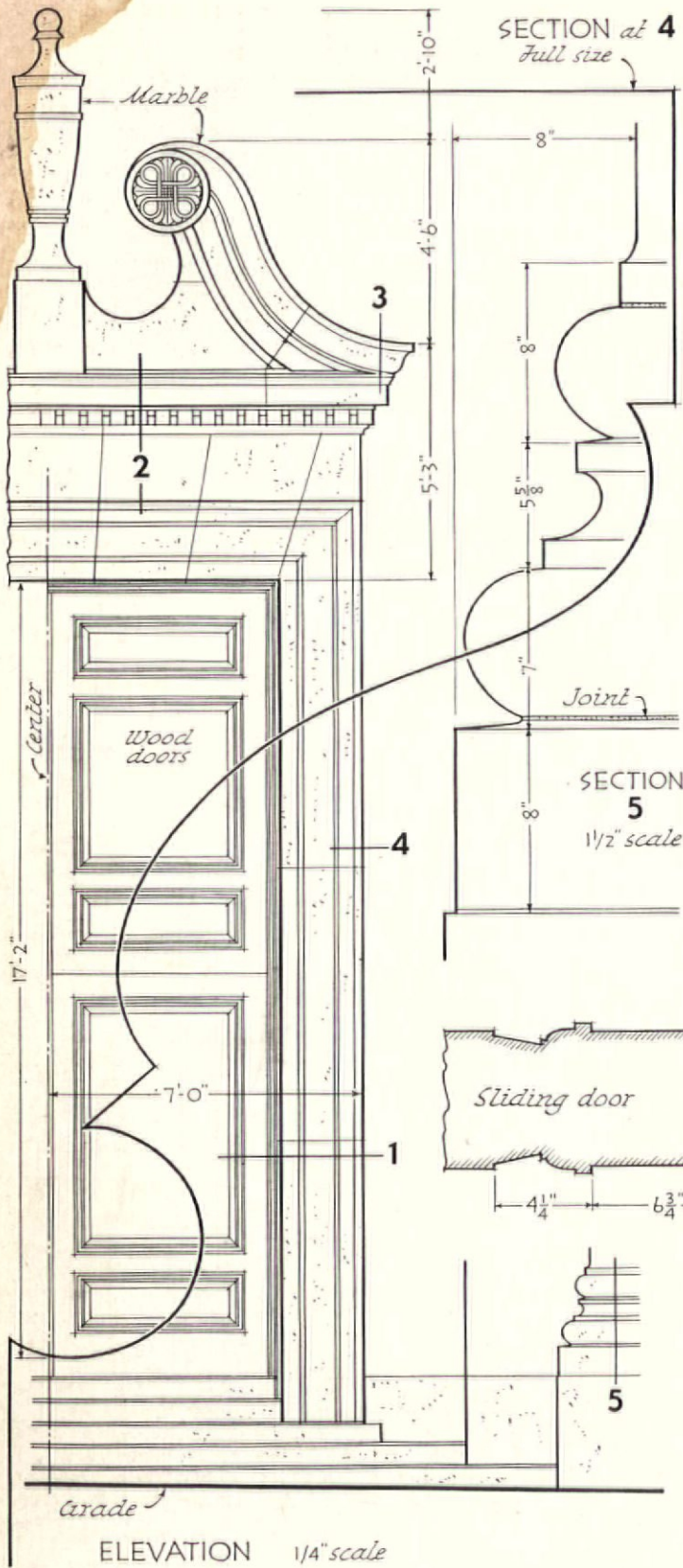

SIGURD FISCHER

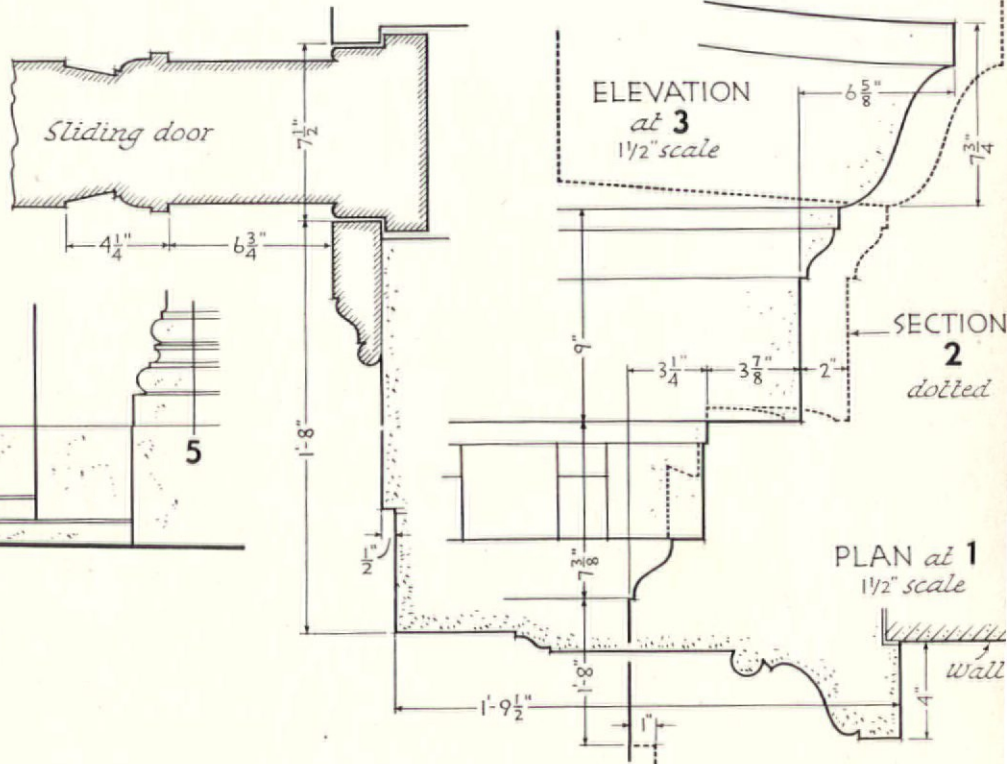

HOBART B. UPJOHN . . . Architect

OTTO F LANGMANN . . . ASSOCIATE